



AMERICAN POWER BOAT ASSOCIATION

American Power Boat Association

Rules for Offshore Racing

APBA Offshore, Offshore Racing Committee, **Offshore Category, and ORC are synonymous terms for the APBA Offshore Racing Committee.**

**AMERICAN POWER BOAT ASSOCIATION RULES FOR
OFFSHORE RACING**

Table of Contents GENERAL

RACING RULES

SECTION I - GENERAL CRITERIA FOR SANCTION AND PARTICIPATION IN EVENTS4
SECTION II - GENERAL CRITERIA FOR RACE MANAGEMENT AND APBA OFFICIALS9
SECTION III - GENERAL PRE-RACE REQUIREMENTS FOR CONDUCT OF EVENTS11
**SECTION IV - GENERAL REQUIREMENTS, PRACTICES AND PROCEDURES FOR
CONDUCTING RACES 14**
**SECTION V - GENERAL POST-RACE PRACTICES, PROCEDURES AND REQUIREMENTS FOR
CONDUCT OF EVENTS.....22**
SECTION VI - AWARDING OF POINTS27
SECTION VII - PRIZE MONEY AND TROPHIES29
SECTION VIII - CHAMPIONSHIPS.....29
SECTION IX - OFFSHORE TIME TRIALS (SPEED RECORDS)30
SECTION X - RULE CHANGES.....33
APBA OFFSHORE EVENT SAFETY RULES.....34
APBA OFFSHORE EQUIPMENT GENERAL SAFETY RULES35
SECTION I - COCKPIT RELATED SAFETY RULES.....35
SECTION II - BOAT, TRAILER, PERSONAL AND RELATED EQUIPMENT SAFETY RULES 35
SLING SAFETY REQUIREMENTS.....44
APBA OFFSHORE TECHNICAL RULES
GENERAL REQUIREMENTS (ALL CLASSES)46
CLASS ONE (1) USA50
SUPER CAT CLASS56
PRO STOCK V (SUPER VEE LITE) CLASS.....64
SUPER STOCK (CAT LITE) CLASS.....70
UNLIMITED (EXTREME LIMITED) CLASS72
VEE EXTREME (SUPER VEE) CLASS73
SUPER VEE XTREME CLASS.....78
EXTREME CLASS RULES83
APBA BRACKETED CLASSES.....84
POWERBOAT P1 CHAMPIONSHIP SERIES RULES87
POWERBOAT P1 SUPERSTOCK CLASS.....89
SS 2 POWERBOAT P1 USA SHORT COURSE SAFETY RULES.....100
APBA OFFSHORE HALL OF CHAMPIONS 105
OPA INSPECTION FORM..... 107

**IF THIS RULEBOOK DOES NOT SPECIFICALLY ALLOW SOMETHING,
THEN YOU SHOULD ASSUME THAT IT IS ILLEGAL. YOU HAVE BEEN WARNED.**

These rules have been promulgated by the APBA Offshore Committee and govern offshore racing under its jurisdiction. The racing rules herein are to provide for the orderly conduct of offshore racing events and to set forth minimum acceptable requirements for them. By participating in these events, involved persons agree to comply with these rules, and to have accepted their priority and suitability. No express or implied warranty of safety shall result from publication of, or compliance with these rules and/or regulation. They are intended as a guide for the conduct of the sport and are in no way a guarantee against injury or death to participants, spectators, volunteers or others. These rules are effective as of the date of printing and shall be in full force. It is the responsibility of the race member to be current and up to date with the current rules. In the case of an amendment to the rules, a new version of the Rule Book will be uploaded and replace the prior version which is then superseded by a new edition (Version # and date will be included on the amended rule book).

IMPORTANT NOTICE

Powerboat Racing is a hazardous activity. Individuals must accept that, by engaging in active water sports such as Powerboat Racing, their physical safety may be endangered.

Anyone intending to participate in or become involved with Powerboat Racing organized by APBA affiliated clubs either as a participant, team member or otherwise does so at their own risk; and such individuals must recognize the actual and potential risks associated with their involvement, including drowning, hypothermia, and other physical injuries as well as possible death.

Participants acknowledge that it is up to them personally to assess whether any event or activity on the water is too difficult for them or their crew. Individuals acknowledge that the safety of their boat and her entire management, including insurance, is solely their responsibility; and they are satisfied that the boat and the crew are adequate to face the conditions that may arise in the course of the race.

Entrants into the event acknowledge that inspection does not constitute a condition survey of the craft and it is solely their responsibility to decide whether or not to start or to continue in any powerboat race. They acknowledge that the efficiency of the helmets and racing vests worn is solely their responsibility.

Individuals on signing on to the event agree (on acceptance of their entry upon being permitted to take part in the meeting;

- (i) To be bound by the conditions of the APBA Entry Form, Racing Instructions and the General Competition Rules of the UIM and the APBA.
- (ii) To accept the decisions of the organizing committee and officials nominated by it
- (iii) To save harmless and keep indemnified:
 - a. The owners of the premises upon which the meeting is held,
 - b. The organizing club, the sponsors and the APBA and their respective officials, servants and agents,
 - c. The other boat owners, drivers, passengers or mechanics engaged in the meeting, AGAINST all actions, claims, costs, expenses and demands in respect of loss of or damage to the signatory's property or the property of his/her drivers, passengers and mechanics—whether or not such loss or damage may have been contributed to or occasioned by the negligence of the said persons or bodies, their officials, servants, representatives or agents.

IMPORTANT NOTE: Persons under the age of 18 must have written authority signed by either Parent or Guardian.

THE RESPONSIBILITY FOR A TEAM'S DECISION TO PARTICIPATE IN A RACE OR TO CONTINUE RACING IS THEIRS ALONE

APBA OFFSHORE GENERAL RACING RULES

SECTION I - GENERAL CRITERIA FOR SANCTION AND PARTICIPATION IN EVENTS

RULE 1 - GENERAL APPLICATION TO ALL EVENTS

The following General Racing Rules apply to all offshore events, including special events such as sanctioned offshore drag racing, and time/speed trials.

RULE 2 • RACE ORGANIZATION AND SANCTION

A. **Eligibility in General** - Any regular member Club or Association of the American Power Boat Association may conduct an offshore race under these rules.

B. Races

1. **Eligibility** - Any APBA Member Club may request a sanction for an offshore event.
2. **Race Dates** - Race date requests must be addressed to the APBA Regional Chairman. All requests must be in writing and include date, place and conducting club. Clubs with returning race dates and sites will receive precedent.

RULE 3 • RACING CLASSES OFFERED

1. The APBA Offshore Racing Committee (ORC) shall have sole discretion as to the creation and deletion of all classes offered in APBA Offshore.
 2. APBA Offshore Classes shall be identified as National or Bracketed.
 - a. APBA Offshore National Classes are:
 - Class One (1)**
 - Super Cat
 - Super Stock
 - Super Vee Lite
 - P-1 SuperStock
 - Super Vee
 - Super Vee Xtreme**
 - Extreme Limited
 - Extreme
 - b. APBA Offshore Bracketed Classes offered are:
 - Class 1
 - Class 2
 - Class 3
 - Class 4
 - Class 5
 - Class 6
 - Class 7
- Requirements for each class are listed in the APBA Offshore Technical Rules.
3. A group of racers may petition the ORC at any time for the creation of a new class. If the ORC determines that there is sufficient interest, then it may approve the new class by majority vote.
 4. Should any currently offered class fail to field entries for three or more consecutive races, the ORC, at its discretion, may remove the class rules from the APBA Offshore rulebook and no longer offer that class. Said action may be accomplished by a simple majority of the ORC and may be done without prior notice.
 5. Any class that has been removed from the rulebook, may petition the ORC for reinstatement should future

interest in the class arise.

RULE 4 · INDIVIDUAL REQUIREMENTS FOR PARTICIPATION IN AN EVENT

A. Membership Requirements -

1. **Riding Crew/Team Owner** - In order to compete in any sanctioned offshore racing event, all riding participants as well as the owner of the boat to be entered must be Racing Members of the APBA Offshore category in good standing.
2. **Support Crew** - All non-riding crewmembers, defined as participants in the Event, must be Crew Members of the APBA Offshore category in good standing.
3. **Local Club Membership** - Additionally, all participants must be members of a Club or Association affiliated by agreement with the APBA.

Conducting Club - Participants agree to be bound by all rules of the conducting club. In the event of a conflict between the conducting club rules and APBA Offshore rules, the APBA rules shall prevail, **unless a special contract has been entered into by the conducting club, the ORC, and APBA.**

5. **Foreign Entries** - Any foreign boat crew may enter an Event provided all members of the riding crew are members in good standing of their U.I.M nationally recognized organization and provided further that they and their boat comply with all other requirements set forth in these rules. Foreign boat crews must be racing members of APBA in order to compete and be covered by APBA participant insurance.
6. **APBA Membership Fees** - Riding team member (**Owner**, Driver, Throttleman, Navigator). Non-Riding team member (Crew): Visit www.apba.org for a list of current fees.
7. **Releases** - All participants in each APBA event must execute a liability release to APBA and/or the conducting club prior to racing. No owner, driver, contestant or their representative or any race official shall hold any other owner, driver, contestant or his representatives or any race official liable for any personal injuries or damage resulting from an accident occurring during a sanctioned race.

8. Eligibility

- a. **Suspension, Expulsion** - No individual who has been expelled from APBA or who is currently under suspension by APBA shall be permitted to officiate, serve as a race committee member, act in any capacity of assistance, participate as a boat owner, driver or crew member in any sanctioned racing event. No boat belonging to that individual shall be allowed to compete nor shall it be chartered or otherwise transferred except by final sale to render it eligible for a sanctioned race.

B. Riding Crew Requirements

1. **Number of Riding Crew** - A minimum of two (2) persons must be carried at all times on a race boat while in competition or during an official test time at an Event.
2. **Minimum Age** - Unless riding with an experienced crew member, the minimum age for a riding crew member shall be 18 years. In the event that another crew member is an experienced offshore racer, the minimum age for a riding crew member shall be 16. For the purpose of interoperating this rule, an experience offshore racer is defined as a racer who has entered, and completed, three (3) offshore races.
3. **Medical and Safety Requirements** - All riding crewmembers must meet the following Medical and Safety Requirements with documentation of proof available at registration to be certified eligible for racing by the Referee and or Medical Director.
 - a) A current Class II FAA Physical Examination or CDL Physical Examination.
 - b) Pre-race physical examination at each event shall be administered by APBA Medical and Safety Staff prior to all test days, speed runs and race events.
 - (1) ZERO tolerance for Alcohol. Decision of Referee is final.
 - (2) Random Drug testing is allowed. There will be ZERO tolerance for illegal substances.
 - c) Self-Extrication Training (Dunker) - (SET) Certification

- 1) APBA SET Certification is MANDATORY for all riding crewmembers prior to competition in any APBA Offshore event.
- 2) All APBA riding crewmembers must be APBA SET Certified a minimum of once each racing season. (December 1 to November 30) by the APBA Medical and Safety Staff. The maximum elapsed time between SET training shall be no more than 12 months from the previous SETdate.
- 3) SET training shall be mandatory for participation at the World Championships or other separate multi-day, combined race events, where separate races are conducted over an extended time frame greater than two days.
- 4) If a participant does not hold a current SET Certification with APBA, and Self Extrication (Dunker) Training is not being offered at that race site, that participant, with proof of “Dunker” training by another recognized sanctioning body, will be allowed to participate at that race only. However, that participant must be APBA SET certified prior to entry in any future APBA events.
- 5) Failure to receive SET Certification in accordance with this rule shall disqualify any riding crewmember from participation in any current or future APBA Offshore event until such time as certification is received.

(d) Basic First Aid and CPR from a reliable certifying agency are highly recommended.

C. Race Boat Ownership Requirements

1. **Ownership** - Offshore race boats may be leased or owned by an individual, a partnership or a corporation provided that the individual, partnership or corporation complies with the APBA membership requirements.
2. **Corporate** - In the event that an offshore race boat is leased or owned by a partnership or corporation, that partnership or corporation must designate an individual who complies with the APBA membership requirements set forth by these rules as its duly authorized representative. This representative shall assume full responsibility for the boat, the boat equipment, and the crew at each race site.
3. **Voting Rights** - The duly authorized representative of a partnership or corporation shall have all voting rights under the rules governing offshore racing.

RULE 5 • RACE BOAT REGISTRATION REQUIREMENTS FOR PARTICIPATION IN AN EVENT (Non-Safety and Non-Technical)

A. Identification (Name and Number) & Hull Registration

1. **Names of Boats** - Any race boat may carry a boat name selected by the owner, but such name shall be subject to the approval of the APBA Executive Director. Lewd, suggestive or vulgar names and/or graphics will not be permitted on race boats. Should such approval be withheld that boat shall be ineligible to compete in any sanctioned APBA event until cleared by APBA. The decision of the APBA executive director shall be final on such matters.
2. **Effective Dates** - Registrations and assignments of racing numbers become effective December 1 and are valid until November 30, unless rescinded or surrendered. When requested, the numbers of the previous membership year will be reassigned.
3. **Replacement or Substitute Boat - See Awarding of Points (Section VI, Rules 8-9)**
4. **Transferability of Number** - No owner may use the same racing number on more than one hull. When race boats are sold, they must be re-registered by the new owner and new numbers assigned, except in those cases wherein the former owner shall consent to the transfer of his number to the new owner.
5. **Annual Boat Registration Fees - See APBA membership application.**

A. Numbers Criteria - All APBA Offshore Classes: Numbers on all race boats shall meet the following criteria:

1. Numbers only, not more than 3 digits.
2. Numbers must be:

- a. Any whole number between 00 and 999 with the exception the number one (“1”). The Number 1 is reserved for the National **High Point** Champion as designated by the ORC and may not be used in any form by another boat in any class. Race numbers shall contain a maximum of 3 digits. No duplicate numbers are allowed. Numbers may include a single zero (“0”) in front of a single- or double-digit number to differentiate the race number from an otherwise duplicate number. (Some examples of legal numbers are: 2, 02, 20, 020, 200, 22, 022, 220, etc.) **In memory of Randy Linebach, the number “24” is permanently retired and may never again be used in APBA Offshore.** #413 was retired for Class 4 in 2012. Boats cannot obtain #413 when running in Class 4.
 - b. Strongly contrasting in color.
 - c. A minimum of 24 inches tall with a minimum stroke of four inches
 - d. On both sides of the hull
 - e. On the deck
 - f. Legible for scoring purposes.
3. Duplicate racing numbers are not allowed. Within all classes of APBA Offshore, every boat shall have a unique identifying number. (No two boats shall have the same number regardless of class)
 4. In the event that two or more boats request the same number, the requested number shall be awarded to the boat using the following criteria:

B. For Unused Numbers

- a. The boat having requested the number first. First request shall be determined by date (postmark or headquarters fax time stamp - no phone calls) of properly executed boat registration and membership application - note: all required fees must be paid in full).
- b. Should two or more applications arrive at the same time, the applicant having raced under that number the longest (regardless of sanctioning body) shall be awarded the number. The owner requesting the number must call and have the previous sanctioning organization confirm in writing the owner’s earliest date of application for that number in that sanctioning body.

C. For Numbers in Use

- a. A number belongs to the owner of a boat and the owner may retain the right to that number as long as he/she keeps their boat registration and APBA Offshore membership current. (Does NOT have to campaign a boat with that number in order to keep the number.)
- b. Should a boat owner fail to register the hull and continue membership in APBA Offshore by the end of the first race of a new year, the number held by that owner shall become available immediately.
- c. An owner may relinquish a number at any time by notifying APBA headquarters in writing that they no longer intend to race under that number. Upon receipt of written notification at APBA Headquarters, that number shall be available to the first person submitting properly executed hull registration and APBA membership forms along with all required fees. (See paragraph 7 immediately below.)
- d. If an owner is awarded an “honorary” number, that number is temporary and the original number belonging to the owner of that boat is reserved for that owner as long as they meet the annual hull registration requirements outlined above. (No additional fees are paid to keep the original number)
- e. No owner may use the same racing number on more than one hull.
- f. If a race boat is leased or sold, the boat must be re-registered by the new owner. New numbers must be assigned, except when the former owner transfers the number in writing to the new owner.
- g. At the discretion of the Referee, temporary race numbers may be assigned.

CLASS NUMBER ASSIGNMENT FOR NUMBERS NOT IN USE

DESIGNATION	SPEED	NUMBER	UIM
Class One (1).....	Unlimited	00 -	
999 Extreme.....	Unlimited.....	00 -	999

Super Cat Lite	Unlimited	S-2 - S-999
Super Cat.....	Unlimited.....	00 - 999
Super Cat Unlimited	Unlimited.....	00 - 999
Super Vee Lite	Unlimited.....	00 - 999
Super Vee.....	Unlimited.....	00 - 999
Super Vee Xtreme.....	Unlimited	00 - 999
Extreme Limited	Unlimited	00 - 999
Class 1	Up to 115 MPH.....	100 - 199
Class 2	Up to 105 MPH.....	200 - 299
Class 3	Up to 95 MPH.....	300 - 399
Class 4	Up to 85 MPH.....	400 - 499
Class 5	Up to 75 MPH.....	500 - 599
Class 6	Up to 70 MPH.....	600 - 699
Class 7	Up to 60 MPH.....	700 - 799

The National High Point Championship in each class will be the only boat allowed to carry the number the #1 for the following season. If the #1 is NOT chosen to be used by the National **High Point** Champion in the class, NO boat will be permitted to use #1 as their number. (Example: If Team A is the 2013 National Champion but chooses to use their register # of 111 in the 2014 season, and Team B who was the National Champion in 2012 and used #101 for the 2013 season, Team B will NOT be permitted to use #101 again for the 2014 season. They must use their previously registered number.)

- a. Production Class boats must follow the boat number rule of a 3-digit number in which the first number represents the class in which the boat runs in. Ex. #101, #201 etc.
 - b. Super Stock must follow the boat number rule of the Alpha-Numeric numbering Ex. S-1
 - c. Other Classes must follow their class numerical system
- D.** American Flags are required on all hulls. The flags must be painted or in decal form. American Flag must be a minimum size of 9"x12". Recommended placement of the American Flags is bow forward and displayed on each hull side. (see below diagram).
- E.** Foreign Entries will place the appropriate flag on the bow in lieu of the American Flag with the same criteria in place. In addition, an American Flag must be placed on the rear corner of the hull where the side and deck meet with a minimum size of 4" x 6".
- F.** APBA Decals must be present on both sides of the hull with a minimum size of 6" x 9". The location of the decal is at the rear corner of the hull where the side and deck meet. For Foreign entries the APBA decal will be placed immediately beneath the American Flag.

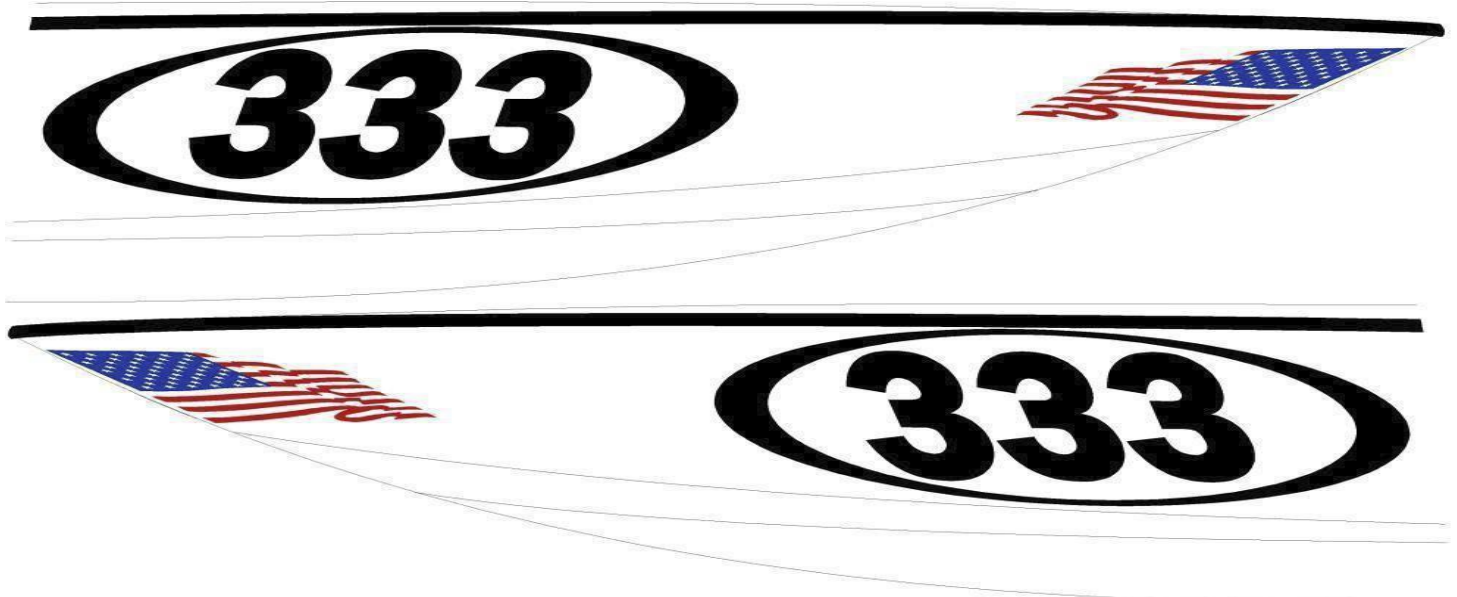

SECTION II – GENERAL CRITERIA FOR RACE MANAGEMENT AND APBA OFFICIALS

RULE 1 - GENERAL APPLICATION TO ALL EVENTS

The following General Racing Rules apply to all offshore events including special events such as sanctioned poker runs and time/speed trials.

RULE 2 - RACE MANAGEMENT AND APBA OFFICIALS

The following APBA officials will be present at all Events to assist with the production and conduction of the Event: Race Chairman, Referee, Assistant Referee, Inspector, Chief Scorer, Medical and Safety Director and Risk Manager.

RULE 3 - REFEREES

A. Chief Referee - The Chair of the ORC shall appoint a category Chief Referee who shall serve at the discretion of the Chair. Among other things, the category chief referee shall be responsible for the preparation and grading of the annual offshore referee test.

B. Presence at Events - Each sanctioned offshore race must have a referee and assistant referee present. Should an officially designated Referee be unable to attend any sanctioned racing event, any member of the ORC may appoint an alternate to serve at that racing event.

C. Duties and Responsibilities -

- 1. Driver's Meetings** - The event referee shall preside over all drivers' meetings. He shall see that all questions relative to racing rules are properly answered and that the conduct of the race itself is in accordance with all racing rules.
- 2. Enforcement of Rules** - The event referee shall see that all racing and technical rules are enforced during the conduct of an Event. It shall be the sole responsibility of the Chief Referee to communicate with any team member or other party who has been charged with the violation of any rule as well as the proposed action that APBA shall take as a result of said violation.
- 3. Post-Race Reports** - The event referee shall file a report in writing to APBA headquarters detailing any accidents or other incidents such as disciplinary actions, and technical disqualifications. The Referee shall report ALL accidents, even though no injuries are involved, to the APBA National Headquarters. This does not preempt local authorities from reporting those accidents, as required by State and Federal law to be reported. Race Officials will assist local authorities in completing their reports where necessary.
- 4. Multiple Roles** - Unless otherwise approved by APBA, the Referee shall not serve in any other official capacity such as Timer, Inspector, etc. nor shall he act as a member of any committee charged with the actual management of the racing event while also serving as the Referee.
- 5. Interpretation of Rules** - Should any questions regarding the interpretation of racing rules arise, the referee shall rule on these. In the event that the Race Committee makes an erroneous decision or interpretation, the Referee is authorized to overrule that decision.
- 6. Special Events and Records** - In those racing events wherein records are claimed, the Referee must ascertain the presence and performance of competent inspectors, timers and timing equipment and course surveyors. The referee must submit a complete report of his findings to APBA headquarters within 10 days of the event
- 7. Unsafe Equipment** - The Referee or inspector shall have the right to refuse any entry at any time prior to the start that in his/her opinion is not designed, built and equipped to standards of seaworthiness and safety required for any adverse weather and water conditions during the race. This shall also be extended to equipment that, in his opinion, hinders adequate competitor extrication and rescue.
- 8. Other** - The Referee of a sanctioned event also must ensure that:

- All proper officials be present and function during the conduct of an event; A safe course is provided.
- The event Chief Medical and Safety Director's Check List has been completed.

RULE 4 – INSPECTORS

A. Presence at Events - Each sanctioned event must have an inspector present. Should an officially designated inspector be unable to attend any sanctioned racing event, any member of the ORC may appoint an alternate to serve at that racing event.

B. Duties and Responsibilities -

- 1. Compliance with Technical and Safety Rules** - The Inspector's main responsibility is to inspect the competitors' racing equipment for compliance with the applicable technical, equipment and safety rules and document their findings on each piece of equipment inspected at an Event.
- 2. Reporting Infractions** - Inspectors inspect racing equipment for compliance with the technical and safety rules. If they find what they believe to be a violation of any rules, then they shall report the infraction to the event Referee.

RULE 5 - CHIEF SCORER

A. Presence at Events - Each sanctioned Event must have a Scorer present. Should an officially designated Scorer be unable to attend any sanctioned racing event, any member of the ORC may appoint an alternate to serve at that racing event.

B. Duties and Responsibilities –

- 1. Timing and Scoring** - The event chief scorer shall have full responsibility for timing and scoring the event.
- 2. Reporting Results** - The event chief scorer shall be responsible for posting all results of the Event in a predetermined and announced location.
- 3. Registration at Events** - The Chief Scorer shall also work as the Chief Registrar and assist in the Event Registration process including the collection, organization and accounting of all entry forms, boat registration forms and membership forms.

RULE 7 - CHIEF MEDICAL, RESCUE & SAFETY DIRECTOR AND RISK MANAGER

A. Presence at Events - Each sanctioned offshore race must have a medical, safety rescue and risk manager officer present.

B. Duties and Responsibilities -

- 1. Support Personnel** - The event Chief Medical, Safety and Rescue Officer shall be responsible for assembling all support personnel necessary for the satisfactory execution of his duties and responsibilities.
- 2. Race Day** - On the morning of each race, the event Chief Medical/Safety Director and Risk Manager or his designee shall be responsible for conducting a survey of the course to verify that all check, turn, medical/rescue and patrol boats are on station. The event Referee must be notified immediately regarding the status of the racecourse.
- 3. Local Officials** - The event Chief Medical/Safety Director and Risk Manager is responsible for coordinating with and directing the local risk manager, as well as the local medical, rescue and safety personnel during the Event to ensure that all APBA Offshore safety, medical and rescue requirements are met.
- 4. Reports** - The event Chief Medical /Safety Director and Risk Manager must report any and all safety violations immediately to the event Referee.

RULE 8 - UIM-OFFSHORE REPRESENTATIVE

The APBA Offshore Chairman or a representative approved by APBA ORC will represent APBA on the UIM Offshore Committee.

SECTION III - GENERAL PRE-RACE - REQUIREMENTS FOR CONDUCT OF EVENTS

RULE 1 - GENERAL APPLICATION TO ALL EVENTS

Unless otherwise specified the following General Racing, Rules apply to all APBA Offshore events, including special events such as sanctioned poker runs and time/speed trials.

RULE 2 - DRIVER'S PACKETS

Driver's Packets may be downloaded from the APBA or conducting club's web site.

RULE 3 - ENTRY FORM AND RACE CIRCULAR

Following the issuance of an APBA sanction, APBA headquarters shall send to all appropriate and duly registered offshore racing members a race circular.

RULE 4 - RACE ENTRY AND CREW REGISTRATION

A. Entry Fees - Race entry fee amounts shall be established at the discretion of the conducting club.

1. **Refund of Entry Fees** - Boats voluntarily withdrawing from a race prior to testing shall receive a full refund or have the option of "rolling" the entry fee over to the next race put on by the same conduction club.
2. Boats voluntarily withdrawing after testing and before race day shall receive 50% of their entry fee or have the option of "rolling" the balance over to the next race put on by the same conductionclub.
3. Boats voluntarily withdrawing on race day shall receive 25% of their entry fee or have the option of "rolling" the balance over to the next race put on by the same conduction club.
4. In the event that a boat shows up at an event ready to race, all riding crew members are present, and the boat is unable to start the race due to circumstances beyond their control (i.e.: mechanical failure, hull damage, safety issues, etc.), the owner shall have the option of receiving last place points in their class OR "rolling" the entry fee over to the next event put on by the same conducting club (not both). If the owner chooses the points, the entry fee is considered spent. This option is available only to currently registered APBA Offshore boats that have competed in a prior APBA offshore event during the current season and have paid all registration and entry fees for that event. The decision to take last place points or "roll" the entry fee over must be made prior to the start of the race. **Receiving last place points in accordance with this rule does constitute having actively participated in a race and count towards qualifying for the APBA Offshore World Championship event.** In the event a decision is not communicated to the Referee before the start of the race, the boat will automatically be awarded last place points. The Referee's decision in this matter shall be the final. Note: Boat must remain at the race site until the completion of their class race to be awarded "hardship" points.
5. All entries to the race must be properly registered according to the procedures set forth by the APBA Offshore for that race.
6. Last minute entries are at the discretion of the Referee and or Chief Scorer.
7. No boat may be launched for testing or race entry until all insurance waivers have been properly executed by all riding crewmembers.

C. Race Registration (On-Site)

1. **Requirements** -
 - a. **Deadline** - At all events, each riding crewmember must complete all registration requirements by the time set in the APBA race circular. All required signatures and any other missing information on the entry must be provided by this time.
 - b. **Paperwork** - Riding crewmembers must show proper APBA membership card, APBA club membership card, UIM card if required, and documentation of all APBA Medical and Safety requirements. The boat registration card must also be checked.

- c. **Penalties** - Entrants failing to complete registration requirements prior to the deadline shall receive a fine and/or up to a 3-minute penalty at the discretion of the event Referee. Entrants not completing all registration requirements prior to entering the racecourse on race day **shall be disqualified**.
- d. **Procedures** - The following on-site registration procedures shall be employed at all Events:
- e. **Fees and Paperwork** - The conducting club shall collect all APBA fees due and complete proper application forms for boat registration or APBA racing membership. All APBA fees and completed registration and membership forms shall be forwarded immediately to APBA headquarters upon completion of the event.
- f. **Local Club** - In the event that a potential entrant is not a member of an APBA affiliated local club, they may join the conducting club. The conducting club retains club fees.
- g. **Insurance Releases** - The event chief scorer and/or the registrar for the event shall make sure that all insurance releases/waivers are signed.
- h. **Late Entries** - Late entries at events shall be accepted at the discretion of the conducting club. A financial penalty may be assessed.

RULE 5 - PRE-RACE SAFETY AND TECHNICAL INSPECTIONS

A. Requirements -

1. All race boats entered in a sanctioned race are subject to a **pre-race safety and technical inspection** by an approved Inspector.
2. The time and place of such inspection shall be published in the Driver's Packet.
3. No race boat may be considered a bona fide entrant in a sanctioned race until such time as the Inspector has passed and signed the official pre-race inspection form.
4. It is the responsibility of the owner or riding crewmember to submit his team's equipment for his inspection. If, in the judgment of the Inspector or Referee, a boat and/or safety equipment is unseaworthy, unsafe, or unmanageable, the non-compliance must be brought to the attention of the event Referee. If the Referee determines that the condition cannot be rectified prior to the start of the race, then he shall have the right to prohibit the boat from competing.
5. The Inspector shall examine each entry for compliance with all safety requirements and shall also visually inspect hull, propulsion and engine for compliance with class technical rules. The spirit as well as the letter of these rules shall be enforced equitably to all entrants.

B. Class Placement - The responsibility for proof of legality of equipment and proper class placement rests with the boat owner. If such proof cannot be provided, the Inspector, with the approval of the Referee shall have the right to re-determine the entrant's class.

C. Pre-Race Technical Rules Violations -

1. **Notice to Owner** - In the event that a pre-race inspection finds a technical rules violation the Referee or Chief Inspector must notify the owner of the subject boat or his representative of the specific nature of the alleged violation as soon as practical but in no instance later than the Final Driver's Meeting.
2. **Correction of Violations** - After a race boat owner has been notified of the violation, he shall have until the Final Driver's Meeting for his race to correct the violation, unless he has been disqualified. Should he elect to correct the violation then it shall be his responsibility to have the boat re-inspected prior to said meeting and cleared for competition. In the event the violation is not correct, the boat shall be disqualified.
3. **Appeals** - Should that owner or his representative choose, he may give written notice and \$500.00 appeal fee to the Referee of his intention to file an appeal to the ORC. Upon appeal the Referee shall (except in cases involving intoxicants and unmanageable and unsafe craft rulings) allow the race boat to start provided that the results of that class shall be deemed unofficial pending the outcome of the appeal hearing. Should the appeal be upheld the finish position of the subject race boat shall be declared official. Should the appeal be denied, the boat will be disqualified, the appeal fee shall be forfeited to the ORC, and the results shall be declared official.

B. UNIFORMS

1. Defined -

- a. **Racing uniforms** - will consist of matching team T-shirts and slacks that simulate a jumpsuit or matching jumpsuits and will be worn on race days.
- b. **Dress Uniforms** - should consist of a collared dress shirt, racing jacket (optional), and dress pants. This uniform will be worn at the first drivers' meeting and at all official functions.

RULE 7 - ESTABLISHMENT OF DESIGNATED "PIT AREAS"

A. PIT REQUIREMENTS - At all Events the Race Producer must establish clearly defined, readily identifiable areas for Dry Pits, Wet Pits, and Hot Pits. In all cases these areas must be set apart from the general public by being roped off, fenced, or some other means except that the public may be admitted to the Dry and Wet Pit Areas during designated times. Only contestants, crews, officials, approved regatta workers or current members of APBA shall be admitted to the "hot pit" area. These areas require the execution of Insurance Waiver by all participants (racers, crews, family members, officials and regatta workers - not spectators) for admission. Intoxication within any of the designated pit areas of any APBA member or a signee of the Insurance Waiver is strictly prohibited. The APBA ORC designates three mandatory pit area classifications with the following restrictions:

1. **Hot Pit:** shall be defined as an adequate area around launching cranes, fuel storage, fueling area and launching ramp. Entry into the hot pit requires APBA Offshore Racing, Crew or Official Membership.
 - a. Fueling of boats shall be allowed only in the approved fueling area(s) and designated by the race committee. Fueling or de-fueling of race boats in the water is specifically prohibited. (Fueling at commercial marina pumps on the water or commercial land-based filling stations is allowed.)
 - b. Waste oil and fuel must be disposed of in a responsible manner by all race teams.
 - c. Signs shall be posted around all hot pit areas designating "No Smoking or Drinking of Alcoholic Beverages." Violation will subject offenders to disqualification.
 - d. Enclosed footwear is mandatory in the hot pit area.
 - e. The crane area shall be highly restricted and roped or fenced off from all other areas. No persons shall be permitted to the crane area except specifically authorized personnel. (This is considered part of the "Hot Pits").
 - f. The presence of persons on a boat, which is being lifted by a crane, is strictly prohibited. Violation of this rule shall result in disqualification from that event.
2. **Wet Pit:** shall be defined as those docking areas, so secured by the race committee, as crew working areas and available by controlled admission pass to the general public.
3. **Dry Pit:** shall be defined as those areas where trailered craft are on display by admission pass prior to launch. This may also be posted with local authority restrictions.

RULE 8- TESTING

- A. **Inspections and Registration** - Race boats must pass through pre-race technical and safety inspection, and the boat and all riding crewmembers must complete all registration requirements **prior to any on water testing**. The owner and all riding crewmembers must sign the Insurance Waiver prior to any on water testing. Anyone testing without signing the Waiver shall be subject to disqualification.
- B. **Compliance with Government Regulations** - Race Teams and Race boats shall be subject to all Coast Guard, Federal, State and local regulations during testing.
- C. **Compliance with APBA Rules and Regulations** - Race Teams must comply with all APBA rules and regulations established for each particular Event, including obeying manatee zones, speed zones, testing times, and testing only in designated areas, if applicable. The teams shall be solely responsible for checking with the appropriate APBA Officials at the Event during registration as to the applicable rules and regulations for testing at the event. Violation of this rule may result in fines, time penalties and/or disqualification.

- D. **Safety Equipment** - Whenever registered equipment bearing APBA numbers or designation is being operated at or in conjunction with a sanctioned event, including while testing, or at any other times while the craft is on plane, or while off-plane under its own power and within 250 feet of the outside of an active race course, the competitors must wear complete personal safety equipment including helmet and life jacket. This rule shall be in effect at a race site from the time of arrival and until one hour after the checkered flag of the last event of the day.
- G. **Lifting Harnesses** - All boats are required to provide their own single point lifting harness for weighing purposes. Slings may not be provided by the Race Committee other than for emergency boat retrieval or if extenuating circumstances exist. In this situation, the referee has the authority to approve such use. See Sling Safety requirements in the General Safety Rules below.

RULE 9 - DRIVERS' MEETINGS

- A. **Attendance** - Drivers' meetings shall be confined to riding crewmembers, boat owners and officials only. Unless otherwise provided in these rules **attendance at these meetings is mandatory for every driver**. The Race Committee may designate representatives, etc. to attend as observers.
- B. **Driver's Meetings** - A Driver's Meeting shall be held on each race day of an Event. Attendance at this meeting is mandatory for every driver competing in that day's races. Unless otherwise noted on the official APBA Offshore race circular, the Final Drivers' meeting shall be held at 9:00 AM on race day.
- C. **Excused Absences** - **A Driver may be excused from attending Driver's Meeting provided** that unavoidable circumstances prevent a driver's attendance and that he provides the Referee sufficient notice, a reasonable excuse and receives the Referee's permission prior to the Meeting.
- D. **Unexcused Absences** - The Referee shall call the initial roll call at the Drivers' meetings and verify the presence of each Driver. The unexcused failure of a Driver to answer roll call at either meeting may result in a fine and/or **up to a 3-minute penalty**. Failure to answer final roll call at the end of the meeting may **result in penalties up to and including disqualification**.
- E. **Changes to the Event** -
 - 1. Any race postponement or substitution of an alternate storm course shall be announced no later than the drivers' meeting to be held one hour prior to the starting time. The Race Committee shall adhere to the schedule set forth in the Race Packet unless some emergency shall dictate otherwise.
 - 2. The Referee may change the course, announce any permanent rule changes, temporary rule changes or amend the instructions for the event at any time prior to the start of a race provided that the teams are notified prior thereto.
- F. **Alcoholic Beverages** - Sale or consumption of alcoholic beverages is strictly prohibited at all drivers' meetings.

SECTION IV - GENERAL REQUIREMENTS, PRACTICES AND PROCEDURES FOR CONDUCTING RACES

RULE 1 - GENERAL APPLICATION TO ALL EVENTS

Unless otherwise specified the following General Racing, Rules apply to all offshore events including special events such as sanctioned poker runs and time/speed trials.

RULE 2 - RACE COURSE

- A. **Check Points** - All check points shall be buoys, boats, or landmarks. If the Coast Guard specifically prohibits the use of fixed buoys, then definite positioning of a checkpoint from that fixed mark may be used. Latitude and longitude coordinates for the positioning of check boats must be utilized for course verification on race morning.
- B. **Check Boats** - All check boats will fly one 3' x 5' orange pennant from the highest point above the water line and one specifically designated flag. A Race Committee may designate any additional distinctive markings from time to time at their discretion to distinguish check boats readily from surrounding spectator

craft or other inhibiting backgrounds. Numbering the orange flags to correspond with the check boat number is mandatory.

- C. **Slots** - Slots may be established on the race course to aid in scoring or enhance the safety of the racers or spectators.
- D. **Spectator boats** - Spectator Boats are not allowed inside the course and may not be closer than 500 feet to the outside race lane.
- E. **Turns Greater Than 90 degrees** - Whenever possible any turn that is greater than 90° should be marked with a minimum of 2 buoys and 2 turn boats at least 1000' apart.
- F. **Storm Course** - In the event that inclement weather conditions prevent a race from being run, the Referee, in conjunction with the U.S. Coast Guard and any other governing law enforcement agencies, may substitute a storm course. Said course must be in protected waters and afford a greater degree of safety to the race boats as well as patrol, medical and safety boats. Alternatively, storm courses may be shortened versions of the original course or run a reduced number of laps on the original course. In any event, the distance run must be at least ½ the distance advertised in the original racers packet.
- G. **Course Markers** -
 - 1. **Turn Buoy** - Any buoy used to designate turns, chutes or slots should be a minimum of five (5) feet tall, either tetrahedron in shape (preferred) or round, orange in color, and made of vinyl or plastic material capable of withstanding conditions encountered in offshore racing. All other marks of the course should be day glow orange, yellow or pink and a minimum of two (2) feet in diameter. All turn marks of the course must be negotiated as designated by these rules, pre-published race instructions or as directed by the referee or his designee at the Final Drivers' Meeting.
 - 2. **Spectator Areas** - All designated spectator areas must be at least 300 yards from any check or turn boat.

H. **Starting Chute** -

- 1. **Minimum Width** - The minimum starting chute width shall be 100 yards.
- 2. **Minimum Length** - The minimum starting chute length shall be one mile. There shall be a minimum of two (2) statute miles from the start line to the first turn. Racecourses with less than two (2) statute miles from the start line to the first turn may be accepted with the approval of the event referee.
- 3. **Other Requirements** - The chute must be maintained in a straight line to avoid “pushing” of the boats during the starting procedure as would happen in a turn. The Start/Finish line shall be defined by boats, buoys or fixed points, one on either side of the course to form said line perpendicular to the direction of travel. All competing boats must cross the starting line between the markers. The finish boat shall fly an orange pennant 3' x 5', or a specifically designated flag. In the event of two such boats, only one side will be designated the “Finish” boat. Timing, scoring and checkered flagging will be done on the official Finish Boat. Race boats must finish close enough to the Finish Boat to be identified, but they shall not pass closer than 50 yards of any stationary vessel. The use of binoculars to confirm passage is permitted. The racecourse must include provisions for the “Safe Area” during starting procedures.

NOTE: Race Control must be equipped with both Aircraft VHF and Marine VHF Radio Base for Medical and Safety Communications.

I. **Race Course Length, Width and Race Distances**

- 1. **Course Length** - At the discretion of the conducting club.
- 2. **Course Width** - The minimum distance from the racecourse to any fixed object shall be 50 yards and the minimum course width shall be 100 yards.
- 3. **Race Distances** - At the discretion of the conducting club.

RULE 3 - PRACTICES AND PROCEDURES FOR CONDUCTING THE RACE

A. General

1. The procedure for each race will be announced at the mandatory drivers' meeting(s.) All racers must adhere to this procedure.
2. All APBA Offshore regular season races shall consist of one (1) full distance race or two (2) separate heat races for each class. Classes may be combined in races to achieve spectator appeal in the event of low boat counts, etc.
3. When the heat race format is used, the total combined distance of the two heats for each class shall not exceed the total full distance races for said class as specified in these rules. Except as noted, any changes/repairs may be made to the boat, engine(s), drive(s) or propeller(s) between heats. **No adding of fuel and no addition or removal of weight between heats.** Riding crew may not be changed between heats. Boats must return to and remain at the wet pit docks and may not be craned out of the water between heats unless they have specific permission from the APBA inspectors. Heats shall not be delayed for a competitor that is not ready when their second heat is called.
4. All boats in weight-regulated classes must report to the crane immediately upon completion of the race. No private cranes or scales will be utilized for official weighing. The APBA Offshore scale(s) is/are the only official scale(s) and as such may not be protested.
5. Radio or cell phone communications between aircraft or shore crews are permitted as long as information received by the race boat does not give an unfair competitive advantage or contain unsportsmanlike comments.

B. Flags

1. **Size** - All signal flags shall be a minimum of two feet by three feet.
2. **Purpose** - Flags are used to give specific instructions to contestants and shall be designated as follows:
 - a. **RED** - Emergency - Stops the race. If used at the start of a race, monitor channel 78A for restart instructions. Any other time return to the milling area at a safe and prudent speed via rules of the road. Red flares or lights may be in conjunction with red flags.
 - b. **SINGLE YELLOW** - Caution. Also used to bring the fleet from the wet pits to the milling area and during the actual pacing of the start. May be displayed at any checkpoint or flown by rescue/patrol craft during a race to indicate an accident or hazardous situation on the course.
 - c. **ORANGE (OPTIONAL - DEPENDS ON STARTING METHOD)** - Denotes that orange smoke has been lit and there are 3 minutes or less until the start of the race.
 - d. **GREEN** - Starts the race. When the pace boat displays the green flag, the race has officially started.
 - e. **CHECKERED** - Finish of race. Return to pits at a safe and prudent speed via rules of the road.

Flags



Start

Starts the race or the race is underway.



Finish

Official finish of the race.



Parade Lap

Parade lap at start of race or caution area is underway



Emergency

Emergency, race has been stopped.

Water Patrol Flags



Stationary Boat
Turn Boat
Start/Finish Boat

ORANGE



Sweep Boat

Purple



Medical Rescue Boat



May have inverted colors

- C. **Pace Boats** - Unless circumstances prevent it, one pace boat shall be employed for every start. Pace boat personnel shall be limited to a maximum of five (5) as designated by the referee: a driver, driver assistant, flagman, flagman assistant, and starter. The pace boat shall be a minimum of 30' and shall be able to attain speeds of 50 to 70 mph. Back-up pace boats are limited to seven (7) personnel, two of which may represent

E.M.S. personnel. The minimum age of pace boat personnel shall be 18 years. Safety takes precedence over racing so pace boat personnel should do nothing to endanger themselves, spectators, or other participants. All pace boat crew must wear their P.F.D. at all times while the pace boat is on the racecourse including during starts.

Turn & Media/ Photo Boats, VIP Rides No Media personnel or Photographers are allowed on any pace boats or turn boats without the express permission of the Director of Race Control and the named boats captain. Any Media/Photo boat wishing to be placed adjacent to the race course must have the permission of the Director of Race Control, execute a liability release and will be located in a safe distance & area of the Race Course. No VIP rides of the Race Course may be given without permission of the Referee, Chief Starter and Director of Race Control. Advanced Notification on all the above is required.

D. Starting Procedures:

1. Pace Lap / Flying Starts:

- a. Boats shall be led from the wet pits or a designated holding area to the race course by one or more pace boats flying a single yellow flag.
- b. Boats from one or more classes may be grouped together for a start or classes may be instructed at the drivers meeting to follow a designated pace boat for their individual start.
- c. The pace boat(s) will lead the boats around the course at approximately 50-60 mph for one lap. Just before the pace boat reaches the pre-determined starting chute, the pace boat will slow to a maximum speed of 40 mph and the boats will line up side by side in a straight line a minimum of 300' behind the pace boat.
- d. When the boats are lined up in proper order and the starting line is straight, the pace boat will simultaneously change the flag from yellow to green and racing shall commence. Note: All boats registered for the race must be in line for the start. The starter must make sure that no boat(s) is/are behind the starting line-up unless they are making a "rookie start".
- e. Starting order for each race of the season and the first race at the World Championships shall be determined by lottery.
- f. If at any time during the starting procedure a red flag is raised, the start has been aborted and all boats are to slow to an idle immediately. Boats should monitor VHF Channel 78A for further instructions.
- g. Rookie drivers and/or throttlemen must start 100 yards behind the field in their start. A rookie driver or throttleman is defined as a new driver or throttleman or any driver or throttleman that has not competed in an offshore race sanctioned by a recognized sanctioning body during the last 5 years. The Referee shall be the sole determinate as to whether or not the rookie driver or throttleman shall be cleared to start with their class at the next event or start 100 yards behind the field again.

2. Milling Group / Pace Boat Starts:

- a. **Leaving the Wet Pits** - The main pace boat and back-up pace boat shall leave the pits together followed by all racing craft. The pace boat shall display the Yellow Flag while leading the race craft to the milling area **or on a parade lap around the course** as announced by the event Referee at the Final Driver's Meeting.
- b. **Milling Area - Immediately following the parade lap the pace boats shall** establish distinct safe area where each starting group can establish the required milling circles. In this area, boats must be off plane (bow down, no wake, 7 M.P.H.) only and must turn in the same direction, counterclockwise. The milling area shall be defined as the actual "circle" created by the boats in a specific starting group.
- c. **Pace Boat Pre-Start Position** - Establish a Picket line, which is effectively where the pace boat turns to pick up each class to lead them down the start chute. Each pace boat designated for a particular start will be placed directly in front of the milling circle of the group it is assigned to start, bow facing the circle. The pace boats will remain with its bow pointed away from the direction of the race course (towards the fleet) from the time that it arrives at the milling location until the start of the race.
- d. **3 Minutes to Start Signal (Orange Smoke)** - Orange smoke and an orange flag will be displayed in view of the milling circles from pace boat #1 to signal that the course has been cleared and the start

procedure will begin in three minutes.

3. The Start -

- a. The official pace boats will start all classes individually or grouped as announced at the drivers' meeting.
- b. The pace boat shall drive a course closest to one side or the other of the chute.
- c. After the three-minute orange smoke/flag period has expired, the pace boat will display the yellow flag, then rotate in position, and come on plane in the direction of the first leg of the course bringing the fleet on plane and in line for the start. The pace boat will not pass in front of the fleet.
- d. All race boats shall stay on the designated side of the pace boat.
- e. Subsequent starts shall be made in the identical manner by pace boats 2 and 3 respectively.
- f. If pace boat 1 is used for subsequent starts, it will return and pick up the fleet without crossing the race course. In this case, pace boat 1 would normally return on the inside of the course, make a sharp, slow speed turn on the same side of the fleet and bring the fleet in line for the start.
- g. The race boats in the subsequent starts should start forming a line at idle speed to meet the pace boat for their start.
- h. The drivers are to establish a safe zone behind the pace boat of 100 ft. and assure a safe distance between boats.
- i. The pace boat determines the actual start by simultaneously dropping the yellow flag and raising the green flag.
- j. The starter, wearing orange gloves and/or using orange batons and an orange vest (if necessary) over his P.F.D., aboard the pace boat will utilize hand signals to control the starting fleet.
- k. Racing may only begin when the green flag is raised; however, the official start for timing purposes is when the first boat crosses the starting line.

4. Heat Races - Second Heat Flying Starts

- a. If the first heat was started using the "flying start" method described above, then the second heat shall be started using the order of finish from the first heat. i.e.: The first-place boat starts on the pole (lane 1), the second-place boat in lane 2; the third-place boat in lane 3, etc.

5. Aborted Starts - If at any time during the start procedure after the orange smoke has been fired, a red flag is raised, the start has been aborted and all boats must return off plane to the milling area (safe area) for restart. All boats should then monitor VHF Chanel 78A and follow specific instructions of the pace boat.

6. Accidents during starting procedure -

- a. In the event an accident should occur during the start or prior to the first turn/check point, the race may be stopped for safety reasons at the discretion of the referee. Any boat stopping to aid at the scene of the accident prior to the first turn/check point will be awarded only the time lost if the race is *not* stopped.
- b. If the lead boat has completed less than one lap, the race will be stopped by red flags displayed at all turn/check boats and the start/finish line. All boats will return to the milling area immediately via rules of the road for a restart. The restarts will commence in the same order and as soon as possible using the orange three-minute smoke to denote the first start. Racers should monitor channel 78A prior to the restart for additional instructions or information.
- c. If a race is stopped for safety reasons prior to the completion of the first lap and then restarted, one lap will be deducted from the required number of laps to complete the race to compensate for the distance run during the initial start.

7. Disabled Race Boats - A disabled boat, or one that cannot get on plane with its class, must not interfere with the next start in any manner. The disabled craft must go to one side of the chute and wait for a clear lane to commence its start. Should a boat fail to start after its class has started, it may start in a normal fashion any time prior to the checkered flag being displayed. The boat will receive credit for a start and any laps completed before the official end of the race.

8. **Rookie Starts** - A new driver (rookie) in any race must start 100 yards behind their class field. During the new driver's first race, the Referee will judge his ability to perform under race. Should an infraction occur, the Referee may prevent the rookie driver from future participation until the deficiencies are remedied. A rookie is a new driver or a driver that has not raced in an Offshore for the previous five years.

E. Racing Rules of the Road

1. **Applicable Rules and Regulations** - At all times during the execution of a race, or official test session, the applicable U.S.C.G., State and local RULES OF THE ROAD shall apply.
2. **Overtaking** - When two race boats are on the same course or approximately the same course, the overtaking boat shall keep clear of the boat being overtaken, and in passing, shall allow at least 50' of clear water between the stern of the overtaking boat and the bow of the overtaken boat. The overtaken boat shall not alter course so as to compel an overtaking boat to pass within this 50' limit.
3. **Overlap** - Overlap establishes right of way at turn buoys and marks of the course. An overlap is established when two boats are on the same course, or approximately the same course, and the cockpit of the overtaking boat is even with the cockpit of the overtaken boat. The following rules shall apply to an overlap:
 - a. The lead boat has the right of way until an overlap is established.
 - b. Once an overlap is established, the overtaken boat must give the overtaking boat room to clear any course markers.
 - c. The overtaking boat cannot force an overlap once the lead boat has altered her helm for the purpose of turning a mark of the course.
 - d. A safe overlap is the responsibility of the overtaking boat.
4. **Bearing Away** - A boat shall not bear out of her course so as to hinder another in passing to starboard or port.
5. **Absent or Non-Conforming Turn Boat or Buoy** - Should any check boat or turn boat or buoy be absent from its proper position during the course of a race, the Race Committee shall, if possible, replace it. If this should prove to be impossible, the race boat shall negotiate that fixed mark (i.e., the position where the buoy or boat should be) of the course as per race instructions.
6. **Accidents** - All competitors reporting "out of race" must report on 78A (VHF 156.925) to Race Control directly or relay through Angel helicopters or patrol boats. Final communication with Race Control must be confirmed on arrival at crane or pits. Offshore Emergency hand signals shall prevail as published and shall be strictly adhered to. (See pictorial that follows.)

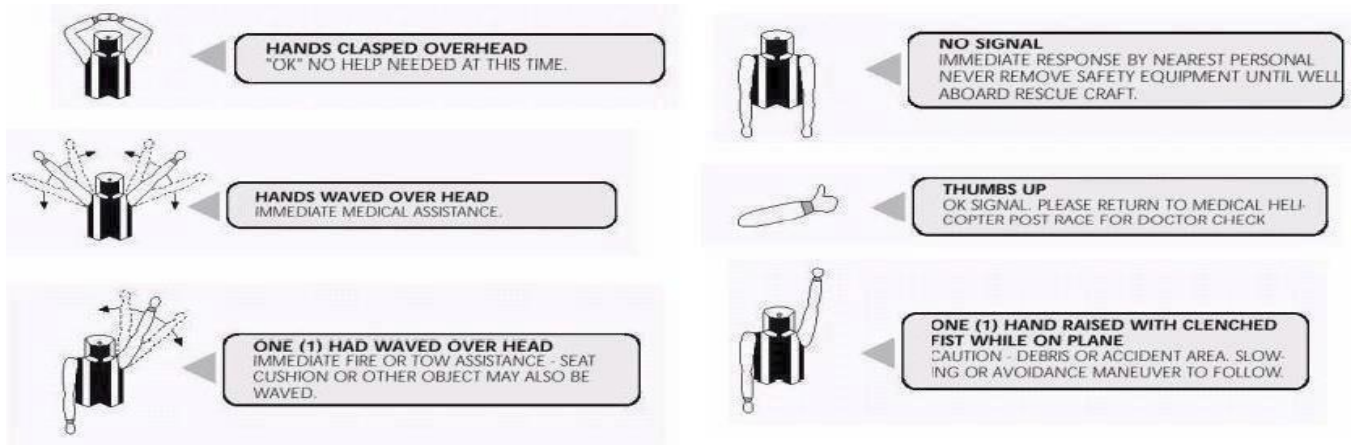

- (a) In the event of a racing accident which includes any occupant being: (1) ejected from a race boat, (2) involved in more than one incidental contact between boats, or (3) involved in a racing accident which in the judgment of the on-site medical personnel qualifies, shall be considered and treated as a trauma victim. All participants involved in an accident that falls into one or more of the above categories will be properly packaged and/or immobilized and evaluated by on-site ALS personnel or medical doctor.

Trauma victims will not be allowed to leave the race site without being released by the ALS personnel or medical doctor. Anyone requiring hospitalization from a racing accident will be required to produce evidence of a complete physical examination prior to entry into any future race.

7. Violation of any of the above rules shall result in three (3) minute penalty.

G. Scoring (Negotiating the Race Course) -

1. **Short Course** - (Courses less than twelve (12) statute miles in length) – All scoring will take place at the finish line. Finishing positions for all boats will be determined at the finish line. The official finish of the race shall be when the last first place finisher in all classes crosses the finish line. Boats still remaining on the course and not having completed the required distance shall be allowed to complete the lap that they are on. Boats not running at race speed at the official finish of the race may receive credit for the lap which they are completing.

Finishing positions for boats that are not on the course at the official finish time, shall be determined at the finish line according to their total number of laps completed and total elapsed time. Those boats not completing a full lap shall receive last place finishing points. Last place finishing points shall be defined as the number of points awarded to the last place finisher as if all entries within that class had completed the full race. (i.e.: 5 boats entered, 5th place = last place) All boats not completing a full lap shall be awarded the same number of points and shall not be awarded an actual place of finish. Their performance shall be recorded as a “START ONLY”. In the event that more than one boat recording a “START ONLY” should qualify for any prizes, then the prizes shall be distributed equally among those boats.

2. **Long Course** - (Courses exceeding twelve (12) statute miles in length) - Finishing positions will be determined at the finish line for those boats that complete the race prior to the official finish time. Finishing positions for boats not completing the race prior to the official finish of the race will be determined at the first scoring point reached at or after the official finish time. After the official finish time, all scoring boats will display a checkered flag for those boats still on the course at the official finish time. Finishing positions for boats that do not complete the course and are not on the course at the official finish time, shall be determined at the farthest scoring point reached. Those boats that do not reach any scoring point within thirty (30) minutes after the official starting time for their class shall receive last place finishing points. Scoring may not be at every checkpoint.

3. **Legal Starts** - All boats must make a legal start within their class in order to receive finish points.

4. **Making the Turn** - All turn marks of the course must be negotiated as designated by the pre-published race instructions or as directed specifically by the Referee or his designee at the Final Driver’s Meeting. All race boats in order to be scored must negotiate these checkpoints at a distance not greater than 300 yards or less than 50 yards from the check point boat. A buoy may be placed 300 yards from the check point boat to aid in identifying the slot. The use of binoculars to confirm passage is permitted. In the event race boats passing properly between turning marks cannot be identified, the score sheet for that checkpoint shall be so noted along with the number of boats not identified, their position, and any partial identification, such as color. The legal passage of an unidentified race boat may be confirmed through the observation of any Race Official, providing such observation is consistent with the information provided on the score sheets, or by the count of boats on the score sheet should such count indicate a boat must have passed through the scoring point.

5. **Missing a Turn** - The course must be taken at all times in sequence. Should a checkpoint be missed, the sequence must be picked up at the point missed and repeated in order to be scored. Should a race boat

fail to execute a mark of the course correctly and hence be compelled to renegotiate this mark, the driver must return and circle inside the course and pass the mark on the proper side, keeping well clear of the balance of the racing fleet in so doing. Any race boat that misses a turn buoy/check point (passes on the wrong side) and fails to renegotiate that buoy correctly shall be penalized one lap.

6. Hitting a buoy - In the event that a buoy is hit by a boat there will be no penalty unless the buoy is dislodged or damaged. In the event that the buoy is damaged or dislodged, the race will be stopped and restarted after the buoy is replaced. The boat that hit the buoy shall receive a one-minute penalty and a maximum fine of \$500. The exact amount of the fine is determined by the conducting club.

H. Course Infractions

1. No Protests

- a. No contestant may protest any other contestant with regard to a failure to properly execute the prescribed racecourse. Judgments on these matters are to be rendered by the check boat judges, pace boat judge, scorer, and the Referee. No penalty for a course infraction may be imposed unless it was witnessed by an APBA Official.

2. Appeals

- a. All decisions of the referee are final regarding starting, driving and course rules, and appeals will be allowed only if disqualification or suspension is involved. Notwithstanding the foregoing, however, failure of the Race Committee or any duly appointed official of that Race Committee, or the Referee or any official designated by him to carry out any provision of these rules or any assignment given him shall have no bearing on the rights of any contestant or upon his responsibility to obey these rules. This shall apply in cases of misplaced check boats, non-conforming turn buoys, failure to control spectator fleets, starting procedures, etc. In these instances, it is the right of the racers to be heard. It is the responsibility of the racer to adhere to rules and instructions. All cases to be heard shall be brought before the Referee.

I. Finish-

1. In order to be scored as an official finisher, a race boat must make a legal start within his class. **THE DRIVER AND THROTTLEMAN MUST REMAIN IN THE BOAT DURING THE ENTIRE RACE.**
2. No Patrol Boat, Check Boat or Turn Boat shall be released from his station until the official in charge at Race Control has given clearance to that specific boat.
3. After crossing the finish line, a race boat shall not interfere with any other boat still in the race so as to affect the time of such boat at the finish or endanger its crew.

J. Emergency Race Stoppage Procedures

In the event that unsafe weather, water, or other conditions either not known or not existing at the time of the start of a race necessitate the stoppage of that racing event, the following procedure shall be used:

1. When such stoppage is to be indicated as race boats pass through a start/finish lane, a checkered flag shall be waved from either the start/finish boat or a patrol boat located in the approximate center of the finish lane. Positions of finish shall be recorded at that point.
2. Should the race have to be stopped at any other point on the race course, a red flag shall be waved and/or a red flare fired from the turn/check boat. When the race has been stopped at a given turn/check point, all race boats are to return directly to Race Headquarters at a safe and prudent speed. Finish positions shall be recorded as they were at the finish line just prior to the stoppage of the race.
3. Emergency race stoppage by pace boat, Race Committee or Medical and Safety helicopter may occur at the discretion of the Referee.
4. Should an emergency stoppage be necessary, the Medical helicopter, turn/check boats and/or pace boat will display a red flag and/or discharge red flares or a thumbs down signal. All boats will then return under safe and prudent Rules of the Road, and finish positions shall be recorded as they were at the finish line just prior to the stoppage of the race.

5. Only the Referee or assistant referee has authority to stop an event.

K. Postponements

1. **Suspension of Event** - Any race that cannot be run due to inclement weather or other unforeseen circumstances may be run at such other time and/or in another location at the discretion of APBAORC.
2. **Wave Height and Visibility** - Hourly postponements will be permitted when weather or other conditions make it unsafe to commence a race at its designated starting time, but where there is a reasonable chance that such conditions will improve. However, in no case shall a race be started after that time which will leave race boats on the course after one half hour before sunset. This decision shall be made by the event Referee, using 6' average wave height and a minimum 2-mile visibility throughout the course as a guideline.

SECTION V - GENERAL POST-RACE PRACTICES, PROCEDURES AND REQUIREMENTS FOR CONDUCT OF EVENTS

RULE 1 - GENERAL APPLICATION TO ALLEVENTS

Unless otherwise specified the following General Racing Rules apply to all offshore events, including special events such as sanctioned poker runs and time/speed trials.

RULE 2 - CONSUMPTION OF ALCOHOL AND /OR ILLEGAL DRUGS

No contestant shall participate in a race, nor shall any official serve in an official capacity, while under the influence of intoxicants, or any dangerous drug which shall include narcotics, depressants, stimulants or hallucinogenic drugs. The Referee shall suspend for minimum of six (6) months any competitor or official whom he believes to be under the influence of intoxicants or dangerous drugs as defined above or during the time the competitor arrives at the race site, on race day, until the competitor has been cleared through post-race inspection and for one hour after the race is over. Ceremonial champagne or equivalent usage in the winner's circle shall be permitted provided that only minor consumption occurs.

RULE 3 - POST-RACE TECHNICAL INSPECTIONS

A. Post-Race Technical Inspections

1. **All Boats Subject To** - All boats are subject to a post-race technical inspection conducted by an approved Inspector. Unless otherwise announced at either of the drivers' meetings, the 1st, 2nd and 3rd place boats must report to inspection. Failure to report to inspection within 1 (one) hour after the finish of the contestant's race shall result in a fine, time penalty or disqualification or any combination of the three penalties at the discretion of the Referee. A list of approved inspectors shall be issued annually by APBA.
2. **Inspector's Discretion** - The event chief inspector has to the discretion to develop and implement an Inspection Plan for each Event and may vary the items and boats to be inspected at each Event. The event Referee may also direct the Inspectors to conduct an inspection of any competing raceboat.
3. **Final Results** - No prize moneys or points shall be awarded until the legality is confirmed by the Inspector(s) to the Referee.
4. **Refusal of Inspection** - Any APBA member refusing an inspection after having been notified by the Referee or Inspector that equipment within his control must be checked for conformance with safety and/or technical specifications shall be disqualified from that event and suspended for sixty (60) days.
5. **Violations** - In addition to the penalties provided in Rule 5, above, the following procedures and penalties shall apply to post race technical inspections and violations.
 - i. **First or Second Offense** - A first offense of a technical nature during a post-race inspection shall result disqualification from the event.
 - ii. **Subsequent Offense(s)** - A subsequent offense(s) of the same nature at any time during the annual racing registration of the boat in question will result in mandatory disqualification from the event and suspension for sixty (60) days.

- iii. **Owner Responsibility** - The owner shall be responsible for the condition of the engine and hull as raced. Errors on part of the manufacturer, boat builder, engine builder, mechanic or previous owner shall not excuse noncompliance with the rules.

RULE 4 - PROTESTS - GENERAL

After posting of unofficial results, within one hour thereof, a protest of the results may be made to the Referee. If heard, the results are final. (No fee is required.) If no protests are filed within the one-hour limit, then the results are considered official and may not be appealed. The ORC shall have the power to review any and all decisions or paperwork resulting from APBA Offshore races and time trials, without a formal appeal or protest and shall have the power to correct any errors up to ninety (90) days after the event.

1. Any racer who has consumed or is under the influence of alcohol or controlled substances is barred from filing a protest or testifying in a protest or appeal. The decision of the Referee is final.
2. Racers have the right to protest Technical rule violations within their class.
3. All protests must be in writing, state which rule has been violated, and accompanied by the correct protest fee. The protest must be signed by the legal boat owner.
4. All protests must be filed with the Referee within one hour of the posting of the unofficial results. Protests may NOT be filed with any other APBA Offshore officials, officers or ORC. If a competitor is unable to file the protest within the allotted time due to unavoidable circumstances, he/she may notify the referee by radio or phone of their intent to file a protest. The Referee shall accept the protest pending delivery of the written protest and protest fee by the protestor within a reasonable time limit as set by the Referee.
5. The Referee shall render a decision as soon as possible, but if necessary, may delay the decision at the race site pending gathering and review of additional information.
6. If the protest is successful, the protest fee will be refunded. If the protest is not successful, the protest fee goes to the boat having been protested.
7. All expenses associated with the protest (tear down, impounding and shipping of parts or any other expenses necessary to adjudicate a protest) shall be paid by the loser. Additionally, the loser will pay for the re-assembly of the engine.
8. A protest may be filed at any time between the completion of the pre-race inspection and one hour after the posting of unofficial results for that class.
9. A post-race protest may not be filed if the protestor was aware of the infraction prior to the start of the race. Protests of this nature must be filed at the earliest possible time to allow adjudication prior to the start of any racing activities for the day. No protests of this type shall be accepted once the first race of the day for any class has begun.
10. If a protest is filed prior to the start of a race or between a series of races consisting of two or more separate races, if necessary, the boat that is being protested shall be allowed to compete in the race(s) prior to the matter being adjudicated and without filing an appeal. The protest shall be resolved after the race or completion of the series of races and, if possible, all awards made publicly. If the protest cannot be resolved at the race site, or an appeal is filed based on the outcome of the protest, then all awards and prizes for that class shall be withheld until such time as the protest and any subsequent appeals have been decided. If the protest is upheld, the performance of the protested boat shall be denied for all races that the boat competed in after the protest was initially filed. If the protest is found to be invalid, then the performance(s) shall be upheld. This rule shall in no way inhibit the right of a competitor to file a protest against another competitor or a competitor that has been disqualified, suspended or expelled to file an appeal in accordance with these rules.
11. Frivolous protests and/or false accusations will not be tolerated in APBA Offshore. Such actions shall subject the protestor to unsportsmanlike conduct penalties.

RULE 5 - PROTESTS - TECHNICAL RULES VIOLATIONS

A. **Protests** - Contestants within the same class shall have the right to protest technical violations of these rules by a competitor in the same class. Technical rules shall be interpreted to be those governing the

qualifications of the race boat itself, its engines, its structure, and its conformance with descriptive rules established to describe its eligibility to compete in its class.

- C. **Written Filing** - All protests must be filed in writing with the event referee.
- D. **Timing** - Protests must be filed in writing with the Referee not later than one hour after the completion of that race along with the required protest fee.
- E. **Specifics** - All protests shall state which rule was violated.
- F. **Notification** - Should the Referee determine that all requirements for a protest have been satisfied, he shall accept the protest and immediately take whatever action is necessary to resolve the protest as soon as possible. Upon acceptance the written protest or a copy thereof shall be provided to the protested team owner or his representative as soon as practical. The decision of the Referee shall be made as quickly as possible and communicated to all parties concerned.
- G. **Handling of Protest Fees** - If the protest is upheld the protest fee shall be returned to the protesting party. Should the protest be denied a portion of the protest fee shall be paid to the owner of the boat protested to defer the cost of any tear down with the balance to be retained by APBA.
- I. **Supervision by APBA Official** - In the event of a teardown under these rules an approved inspector must be present during and supervise the teardown process and file a written report detailing the findings with the ORC.
- J. **Fees** - protests must be accompanied by the proper fee in accordance with the following schedule:
 - 1. \$1000.00 for a Stage I protest.
 - 2. \$2500.00 for a Stage II protest.
 - 3. \$5000.00 for a Stage III protest.

RULE 6 - TEAR DOWN PROCEDURES -

A. FOUR CYCLE ENGINES-

1. Stage I - \$1000.00

- (a) The owner or his crew shall prepare engine for P & G and remove the intake manifold and/or exhaust manifold(s) as instructed by the inspector.
- (b) The inspector may check any part of the engine for compliance with technical rules limited only by the extent of tear down indicated by paragraph 1 above.

2. Stage II -\$2500.00

- (a) The owner or his crew shall prepare the engine for Stage I inspection as well as remove one or both cylinder heads as instructed by the inspector.
- (b) The inspector may check any part of the engine for compliance with the technical rules limited only by the extent of tear down as indicated by paragraph (a) above.

3. Stage III -\$5000.00

- (a) The owner or his crew shall remove the engine from the boat and disassemble the engine completely as instructed by the inspector.
- (b) The inspector may check any part of the engine for compliance with technical rules.

B. Two Cycle Engines

1. Stage I -\$1000.00

- (a) The owner or his crew shall remove an intake manifold and a cylinder head as instructed by the inspector.
- (b) The inspector shall measure port sizes, displacement, compression, venturi sizes, and check for compliance with all or any technical rules and/or specifications at his discretion, limited only by the extent of tear down indicated by paragraph 1 above.

2. Stage II -\$2500.00

- (a) The owner or his crew shall remove the powerhead, exhaust plate, and lower unit from the center section, and also remove the intake manifold, both cylinder heads, and all pistons from the powerhead.
- (b) The inspector shall measure or otherwise check any or all parts of the motor to determine compliance with all or any technical rules and/or specifications at his discretion, limited only by the extent of tear down indicated by paragraph 1 above.

RULE 7 -PROHIBITED CONDUCT -

In addition to the rules violations and associated penalties described above, the following constitutes a list of prohibited conduct and the associated penalties:

A. Course Infractions -

1. **Observed Infraction** - No course infraction penalty shall be assessed to any competitor unless an APBA official has observed the infraction.
2. **Reckless Driving** - Recklessly endangering any craft, patrol boat, medical boat, spectator boat, person, or property shall result in disqualification from the event.
3. **Helmets and Jackets While on Plane** - Any driver or riding crew member who participates on plane in a race, or test session, without wearing an approved life jacket and crash helmet shall be disqualified.
4. **Damaging, Dislodging or Destroying a Turn Buoy** - Every boat must go fairly around the course without damaging, dislodging or destroying any turn buoy unless forced to do so by another boat. In that event, only the offending boat will receive a one-minute penalty and a **\$500.00** fine paid to the conducting club.
5. **Government Regulations** - Any owner, driver, assistant or official, whether competing or not, who shall violate a published local Coast Guard, or Harbor Department regulation or in any way interferes with the racing event may receive a time penalty of up to 3 minutes and/or disqualification from the event.
6. **On plane in spectator area** - Should a race boat fail to come off plane and maneuver with caution out of a designated spectator fleet, a penalty of 3 minutes shall be assessed.
7. **Start Violations** Infractions of starting rules are as follows:
 - a. Jumping start - 1 minute
 - b. Crowding pace boat - 1 minute
 - c. Turning wrong direction in milling area - 1 minute
 - d. Interference with starting procedure - 1 minute
 - e. On plane in milling area - disqualification for the event.
8. **Outside Assistance** -
 - (a) Once a race boat has begun the parade lap or taken the green flag to start the race, accepting any outside assistance to make any changes, taking on fuel, supplies or equipment of any description, to effect repairs, to dislodge craft after having run aground, or any assistance that would thus enable a disabled race boat to continue the race, such as accepting a tow or negotiating any part of the course using any facility except its own power shall result in the boat no longer being scored.
 - (b) All race boats must report to the starting area under their own power. Acceptance of a tow or any outside assistance between the wet pit and the starting line will result in disqualification from the event.
 - (c) Radio communications from shore crews shall be allowed as long as the communications are conducive to the best interests of offshore powerboat racing and do not contain unsportsmanlike comments or interfere with Race Control private channel, VHF or aviation frequency radios.

9. Post-Race Communication with Race Control - Any contestant who fails to report to Race Control their inability to finish as soon as communication facilities permit shall result in a fine up to \$500. Should electrical failure or radio damage preclude transmission, it is the contestant's responsibility to report to the nearest check boat, patrol boat, or official helicopter that he is withdrawing from the event and confirm it with the Race Control as soon as possible.

10. Unsportsmanlike Conduct -

- (a) Verbal abuse, physical assault or improper conduct toward a race official -up to \$1000.00 fine and disqualification from the event plus suspension from APBA Offshore for one year
- (b) Participation by owner, riding crewmember, crewmember or APBA race official in any Calcutta, wager or bet concerning the outcome of an APBA offshore event shall be suspended from APBA for a period of one-year subject to review by the ORC.
- (c) Any violation of the published APBA rules and regulations that is considered by the Referee to be of major importance, including, any action determined to be against the best interests of APBA Offshore, or unsportsmanlike conduct shall subject the offender to probation, loss of points, fines, disqualification from the event, suspension from APBA or any combination of the afore mentioned penalties at the discretion of the Referee. (Unsportsmanlike conduct shall be defined as but not limited to: public intoxication or under the influence of any drug substance that causes impairment of physical or mental functions, fighting, intentional aggressive or reckless driving on the race course, verbal abuse, public criticism, malicious or false accusations or improper conduct toward any APBA member or official and public criticism of APBA Offshore.) Note: Negative comments, criticism or threats of any kind, directed towards APBA Offshore, its employees, officials or members on any public forum (public forums shall be defined as, but not limited to, newspapers, radio, television, public or private internet websites/forums/chat rooms, etc.) shall be considered unsportsmanlike conduct.

11. YELLOW CARDSYSTEM

A. The referee, assistant referee, Board of Directors member, Officer of the Association, or Category Chairperson may give a yellow or red card to a member for unsportsmanlike conduct at the race site during the sanction period.

B. For unsportsmanlike conduct on the race course, the referee shall issue a yellow/red card on or before one hour after the finish of the least heat of racing except when the offense occurs in inspection, whereupon the card shall be issued within one hour after the finish of the last heat or within one hour of the alleged occurrence, whichever is later.

C. On boat-to-boat contact resulting in transport to a hospital, the following procedure shall take place. A decision on whether to issue a red/yellow card shall be allowed up to 72 hours after the incident. Should more time be needed by the referee, the category chairman can grant an additional 3 days from the end of the 72 hours.

D. A yellow or red card may be protested to the race committee. A negative response can be appealed to the appropriate racing commission or committee. In the event an appeal is filed, any penalties shall abate until the appeal is decided.

E. Additionally, up to two yellow cards can be given at one time for dangerous driving, and a red card can be given for extremely dangerous driving.

F. All cards will remain valid through the four events (entire week/weekend) in which the driver competes following the date on which the last card was delivered. If there are no cards given during those four events, all cards expire.

G. A driver who has a valid red card or three valid yellow cards will lose the right to take part in the next APBA competition event (full weekend) in which he would reasonably compete, and his next championship (divisional or national championship) or race series event. Then all existing cards are removed.

H. All cards must be reported to the APBA office within three days of delivery.

I. If a driver receives a third valid yellow card or a red card and is suspended from participation, the APBA office will notify the APBA Chief Referee, driver’s region chairman, club commodore and category chairmen, and post the suspension notice on the APBA website.

J. Suspension or other active penalties for competitors in Junior Hydro or Runabout classes will be reviewed by the Junior Classes Committee before taking effect; unless the committee fails to act within 4 days.

K. Cards and penalties in effect extend into the following season.

L. Payment of Fines - All fines must be paid prior to entry into any future APBA events. If the fine has been issued in conjunction with penalties qualifying for appeal, then the appeal must be written and properly filed within the specified time limit for appeals.

RULE 8 - APPEALS

- A. Filing and Timing Requirements** - An appeal of a penalty imposed under these rules must be filed in writing with the Chair of the ORC and accompanied by a \$1,000.00 appeal fee, within 10 days of the offending party’s receiving notice of the penalty. Failure to appeal within this time will constitute a waiver of all appellate rights.
- B. Hearings** - The Committee shall afford the accused a hearing on all charges. At the discretion of the Offshore Chairman a committee may be appointed by the Chairman to investigate the facts surrounding the alleged rules violations and report their findings and/or recommendations back to the Committee prior to any hearing on the matter.
- C. Appeal Fees** - will be returned to the member only if the appeal is upheld. After the stipulations above have been met, the Committee shall have the power to take such action as it deems appropriate under the circumstances.
- D. Decisions** - The decision of the ORC shall be final and subject only to review by the APBA National Committee and the APBA Board of Directors. Decisions shall be rendered no later than 30 days after the hearing.
- E. Shipment of Parts** - If the resolution of an appeal requires the shipment of a part or parts to a technical committee, then the owner of said part(s) shall be responsible for all shipping and handling charges.

SECTION VI - AWARDING OF POINTS

RULE 1 - GENERAL APPLICATION TO ALL EVENTS

Unless otherwise specified, the following General Racing Rules apply to all offshore event, including special events such as sanctioned poker runs and time/speed trials.

- A. For the purpose of calculating national high points, the overall finish for all heats run as part of each event (generally a weekend) shall be scored as one (1) race. Points awarded per event are given below.**

Order of Finish Points Awarded	Order of Finish Points Awarded
1..... 100	943
2..... 90	10 39
3..... 81	11 35
4..... 73	12 31
5..... 66	13 28
6..... 59	14 25
7..... 53	15 23
8..... 48	

1. In addition to the above, one additional point shall be awarded for each boat that is beaten in each race. For example, a boat that finishes ahead of 5 other boats will receive 5 additional points.

2. In order to receive High Points there must be a minimum of three boats registered in the class at that race to qualify.

B. For races consisting of more than two heats, the overall finish shall be determined based on the total points scored during all heats of the event.

1. Once the order of finish is established, finish points are assigned in the normal manner. i.e.: 100 points for first, 90 for second, 81 for 3rd, etc.

C. Ties (All Racing Series Consisting of Two or More Heats)

1. In the event of a tie in points between any two boats, the tie shall be broken using the following criteria:
 - a. The boat having the greatest number of racing miles (most laps completed) for both races shall be declared the winner.
 - b. If a tie still exists, then boat having the least amount of elapsed time (fastest average speed) for both races shall be declared the winner.
 - c. If a tie still exists, then the Referee shall declare the race an official tie. In case a tie still exists at a championship event, both boats shall be declared champions and awarded duplicate trophies. Prize money shall be split equally between the two boats.

D. Reporting Race Results - Event Chief Scorers must submit results to APBA headquarters from races within fourteen (14) days of the completion of the event.

RULE 6 - NON-TRANSFERABILITY

For all sanctioned APBA Offshore races, APBA National headquarters will tabulate points for the racing year commencing December 1 and ending November 30. Points are awarded to the registered hull listed on the official entry form and may not be transferred except as allowed by these rules. If a race boat is leased or sold during the racing season, the boat must start over in high point accumulation.

RULE 7 - REGISTERED HULLS

In all classes, a separate record of points shall be maintained for each registered hull as tabulated by APBA. Each hull registered shall be given a separate racing number to be used for that season. The number will be utilized in all scoring to maintain records of points earned.

RULE 8 - REPLACEMENT HULLS (Lost or Damaged Boats)

Should the registered hull become damaged, lost or destroyed, (as certified by three (3) members of the ORC or an approved marine surveyor, in writing, at the expense of the owner), it may be replaced by like kind only for completion of that racing season or, if damaged, until restoration of the original hull.

RULE 9 - SUBSTITUTE HULLS (New Boats)

If a new boat, ordered and promised for delivery in writing by the builder, is unavoidably delayed in its delivery due to circumstances documented in writing by the builder, a boat of like kind may be substituted until the new boat is delivered with the substitute hull's points being transferable up to July 1 of the current racing year. The Offshore Racing Committee shall have the authority to grant extensions beyond the July 1 deadline in extenuating circumstances.

RULE 10 - NEW NON-SUBSTITUTE OR REPLACEMENT HULLS

If a registered hull is replaced during the racing season, and paragraphs 8 and 9 are not applicable, then the new hull must pay a new hull registration fee and shall start over in points accumulation.

RULE 11 - Qualification requirements for championship races transfer to new, substitute or replacement hulls as long as all requirements of the above rules are met.

RULE 12 - For purposes of clarification, where two or more races are held as a series such as the World Championship event, all races in that series must be started with the same hull. No changing, substituting or replacing of hulls between races in a series is allowed regardless of loss or damage to the registered hull initially entered in that series.

RULE 13 - ACCIDENT ENCOUNTERS

The first racing craft to encounter an accident scene may stop to render assistance (and notify Race Control on 78A). If the finishing points of the assisting boat are thereby compromised, the craft shall be awarded the points outlined as follows:

- A. **First Boat to Stop** - When one boat stops to assist another boat in trouble: the boat that stops to assist receives points for the position it was in at the scoring point just prior to when they stopped.

- B. **Points and Prize Money** - That boat that actually finishes in that place receives the same amount of points as the boat that assisted, and they split any prize money that would normally be awarded to either or both of the boats.
- C. **Scoring Instructions** - The position the assisting boat actually finished in is skipped. For example, A-1 stops to help at an accident, and at that point he was in third place. There were seven boats running in the class, and A-2 actually finishes third. A-1 and A-2 both receive third place points, and they split third place prize money. The position A-1 actually had been scored in for the finish would then be omitted from the final standings.
- D. **Awarded Time** - If the boat should continue on racing after assisting and if the time out of the race is verifiable, the time out may be taken off to determine their finish. This decision is at the discretion of the Referee and may not be protested or appealed.

SECTION VII - PRIZE MONEY AND TROPHIES

RULE 1 - GENERAL APPLICATION TO ALL EVENTS

Unless otherwise specified the following General Racing, Rules apply to all offshore events, including special events such as sanctioned poker runs, offshore drag racing and time/speed trials.

RULE 2 - DISTRIBUTION OF PRIZE MONEY AND TROPHIES

- A. **Protests** - No trophies or prizes shall be awarded to any driver until such time as all protest fees have been paid and the official results are posted.
- B. **Trophies** - Trophies will be awarded to the first three drivers in each class.
- C. **Prize Money** -
 - 1. **Optional** - Prize money at all races shall be optional.
 - 2. **Official Results** Prize money shall be the sole responsibility of the conducting club. No trophies or prizes will be awarded until all protests or appeals are settled and the official results are posted.
 - 4. **Optional Prizes** - The sponsoring organization may designate any special prizes or cash awards.
 - 5. **Minimum Number of Boats in a Class** - There must be a minimum of **three** boats to establish a class.

SECTION VIII - CHAMPIONSHIPS

RULE 1 - Offshore National Championship Event: One national championship event may be held each year. All APBA offshore classes must be invited to participate at this event. APBA will award double points for an APBA Offshore National Championship event. (There is no requirement that an APBA Offshore National Championship event be held.)

RULE 2 - National High Point Championship:

- 1. The APBA National High Point Championship shall be awarded to the team within each class that scores the highest point total in all regular season races plus the points awarded for the APBA National Championship Race plus shall be declared the national champion in its class.
- 2. In order to be declared the National Champion in any class, the boat must have attended a minimum of $\frac{3}{4}$ of the regular season races and actually run or compete in the APBA National Championship race. For purposes of clarification, “attended” shall mean the boat, driver and throttleman were present, ready to run with all entry fees paid. If a race was cancelled due to circumstances beyond control or the boat broke down prior to the start of the race, then the “attended” requirement shall be considered satisfied).
- 3. In case of a tie, see the current rule Section VI, Rule 1, paragraph C - “Ties”.
- 4. If a tie cannot be broken using the above, the P1 high point championship shall be awarded to the driver who accumulates the highest point total using the P1 point system. In all other offshore classes, the high point championship shall be awarded to the driver who accumulates the highest point total using the APBA point system.

RULE 3 - Divisional Championship Event: One divisional championship event may be held each year in each division. All APBA divisional offshore classes must be invited to participate at this event. (There is no requirement that an APBA Offshore Divisional Championship event be held.)

1. Offshore Divisions:

East: All states east of Texas, Oklahoma, Kansas, Nebraska, South Dakota and North Dakota.

West: All states west of Texas, Oklahoma, Kansas, Nebraska, South Dakota and North Dakota including Texas, Oklahoma, Kansas, Nebraska, South Dakota and North Dakota

RULE 5 - APBA/UIM World Championships

All APBA or UIM classes shall be eligible to participate in UIM World Championships hosted by an APBA club.

1. To qualify for the APBA Offshore World Championship, a boat must have participated in a minimum of two offshore events sanctioned by any nationally or world recognized sanctioning body between January 1 and November 30 of the current racing year. The same driver and/or throttleman must have competed in the same hull (or a hull that qualifies under Rule 27, Section C of these rules) in the same or equivalent class in which they are entered at the world championship event.
2. Only classes currently defined in the APBA Offshore rules shall be eligible to compete for World Championship titles.
3. APBA Offshore World Championships shall consist of a minimum of two separate races. Both races shall be full distance races in accordance with these rules unless one or both of the races is shortened by the Referee for safety or reasons beyond control of the APBA Offshore.
4. Each race shall be scored in accordance with section IV, Rule 4, Section F, paragraphs 1 and 2 of these rules. The points from each race shall be added together and the boat in each class with the highest total number of points for both races shall be declared the World Champion in that class.
5. In the event of a tie in points between any two boats, the tie shall be broken using the following criteria:
 - a. The boat having the greatest number of racing miles (most laps completed) for both races shall be declared the winner.
 - b. If a tie still exists, then boat having the least amount of elapsed time (fastest average speed) for both races shall be declared the winner.
 - c. If a tie still exists, then the Referee shall declare the race an official tie. Both boats shall be declared World Champions and awarded duplicate trophies. Prize money shall be split equally between the two boats.
6. In the event that weather or any other conditions beyond the control of APBA Offshore force the cancellation of one of the races, the World Championship will be decided based on the outcome of one race only. In the event that both races are cancelled, then no World Champions will be declared for that year.
7. Entry fees for all races are established by the conducting APBA club.
8. In the event that a boat is declared unsafe or damaged beyond repair (as certified by the Chief Inspector and/or the Chief Medical and Safety Director) at any time during the World Championship event, that boat may request a pro-rated refund (credit) of their entry fee. All refunds shall be made in the form of a credit towards entry fees at an APBA offshore race prior to (but not including) the next year's World Championship Event.

SECTION IX - OFFSHORE TIME TRIALS (SPEED RECORDS)

RULE 1 - SANCTION

Any APBA regular member Club may conduct time trials. APBA will not approve a sanction for a time trial for a single boat. Should there be a request for a single class time trial, sanction would be granted provided that all

the rules governing time trials are adhered to. A race circular advertising the trial as open to all registered boats in that class, must be circulated. The Event Organizer receiving the sanction for a trial shall be responsible for all of the expenses of sanction and conduct of the event.

RULE 2 – ELIGIBILITY

A. Qualifications -

1. **Classes** - All APBA Offshore classes are eligible to compete for records at sanctioned Offshore time trials.
2. **Riding Crew Members and Boat** - The combination of the driver and/or throttleman and the registered boat, as shown on the official entry form, (same serial number of hull that the driver and/or throttleman qualified in) must have competed in at least one Offshore event sanctioned by any recognized sanctioning body within the past 12 months in the same or equivalent class prior to the date of the trial. The driver and throttleman do not have to perform the same functions during the kilo run as they did in the qualifying of the registered boat. The hull must have been registered in accordance with these rules and the qualified driver and/or throttleman must have been full annual members when the qualification race was run.
3. **Substitute or Replacement Boats** - Unqualified substitute or replacement hulls, regardless of serial number, are not eligible for records. In order for substitute or replacement hulls to qualify for a kilo record, the substitute or replacement hull must meet all of the qualification criteria listed above. Substitute or replacement hulls that have qualified and are eligible for kilo records must meet all current class requirements.
4. **Other Requirements -**
 - a. **Compliance with Rules** - The boat shall undergo a pre-event and post event safety and technical inspection in accordance with the applicable class rules and otherwise comply with all technical and safety specifications as established for any other racing event covered by these rules.
 - b. **Ownership of Official Records** - Any official record established at a sanctioned Offshore time trial shall belong to the registered owner of the subject race boat but may be entered under the name that said owner shall designate, provided that the designee is the owner, driver or throttleman.
 - c. **Course** - Runs shall be made only on officially surveyed courses.

RULE 3 - COURSE

- A. **Length** - For a valid record to be established the course upon which the time trial is conducted must be a minimum of one kilometer **or ¼ mile.**
- B. **Approved Survey** - The course shall be approved by an official Surveyor holding a certificate of competence from a recognized institution under the direction of a representative of APBA. The course shall be measured by triangulation. The official Surveyor shall provide a certificate in duplicate verifying the execution of the above requirements. This certificate shall be signed by the Surveyor and countersigned by the representative of the APBA and forwarded to National Headquarters with the results of the speed runs.
- C. **Fixed Landmarks** - For the purpose of a record, only courses based on fixed landmarks are recognized.
- D. **Marks of the Course** - The course shall be marked at either end by permanent markers placed on shore with approved distinguishing marks affixed to them. Steering marks may be placed wherever needed. In wide bodies of water, the width of the course may be marked off at each end with two buoys moored at a distance of one hundred yards from each other. The boats must run between these buoys.

RULE 4 - TIMING AND SCORING EQUIPMENT AND PERSONNEL

The timing shall be performed by the APBA-Kiekhaefer Scanner System, Eastman Scanner Timer, Utah Speedboat Association Timing Subcommittee, Region 10 light emitting, diode triggered Kilometer Scanning Equipment and must be operated by a minimum of two qualified timers at each scanner position who are members of the APBA. Alternative methods and equipment shall be approved by the Timing and Timing Equipment Subcommittee and shall be stated in these rules upon subsequent printing of the Rule Book. The

basic components of record timing systems must include, but are not limited to, the following: **Scanners** - Two (2) manually operated scanners or photoelectric devices, which accurately activate and deactivate timers at the exact instant a contestant's boat bow enters and leaves the trial distance. Maximum error if said scanner or photoelectric devices is as specified on the Time Trial Representative's ReportForm.

- A. **Timing System** - A timer system, consisting of at least two (2) electronic digital, or one (1) electronic and one (1) mechanical, or (2) mechanical stop watches, electrically activated directly by the system described in paragraph (a) above. In the event the two watches do not agree, both times will be recorded, and the official time established from the watch with the least error factor as certified following the regatta.

RULE 5 - PROCEDURES FOR CONDUCTING THE TIME TRIAL

- A. **Timing and Scoring** - The test shall consist of two consecutive runs, one of which shall be made in one direction and one in the opposite direction. The boats shall be timed on each of these runs as provided above. The times, as indicated by the watches for each run, read to the hundredths of a second, shall be averaged and the average speed for each mile or kilometer run shall be taken from the pre-computed Speed Tables available from APBA National Headquarters or computed from the formulas contained in the APBA Reference Book. All times shall be measured to 1/100th second, or better, and all times shall be recorded to 1/100th second. The sum of the speeds for the two runs shall be computed and this sum shall be divided by two. The quotient will be the average speed of the boat in miles per hour. (Note: From 200 kilometers an hour, or 125 mph, upwards, UIM requires that timing must be done at a 1/100th of a second, by photo electrical apparatus if possible.) In speed records, the time elapsing between the two runs must not exceed fifteen (15) minutes. If such should be the case, the entry is scratched.
- B. **Aborted Runs** - If during the course of the trial a driver should desire to re-start his/her run (because of mechanical or handling difficulties, for example) he/she may do so one time in each direction without penalty.
- C. **Time Limitation** - In speed records, the time elapsing between the two runs must not exceed fifteen (15) minutes. If such should be the case, the entry is scratched.
- D. **Riding Crew Members (Minimum Number)** -A minimum of two persons must be in each boat during a time trial pass.
- E. **Starts** - All starts shall be "flying starts" and the timing will commence when the bow of the boat crosses the starting line.
- F. **Running Order** - Order of running shall be either by lot or by order of entry.
- G. **Number of Attempts** - Time permitting and following the completion of trial runs by the entire field, a driver may be given permission to make additional runs in an effort to better his initial trial run. The order of such reruns shall be the same as that established for the initial runs.
- H. **Medical and Safety Requirements** - Four (4) patrol boats required, two (2) of which will serve as Medical Rescue with A.L.S. equipment and personnel as approved by the Medical and Safety Director. A licensed A.L.S. ambulance must be present at the site during all speed runs and testing.

RULE 6 - OFFICIAL RECORDS - REQUIREMENTS

- A. **Speed Differentials** - No record shall be awarded unless the new speed equals or betters the previous speed multiplied by 1.003.
- B. **Committee Approval** - All records must be approved by the ORC to become official.
- C. **Post-Race Inspection** - All boats establishing records are subject to inspection immediately following their performance runs unless the boat is entered in another racing event in the immediate future. If this be the case, the engine must be sealed and all other necessary steps to preserve the boat in its record run condition must be taken by the Inspector pending subsequent inspection.
- D. **Presence of Referee** - No official records shall be awarded unless an official Referee is present.
- E. **Official Reports** - All time trial officials must file the results on those forms provided for the purpose. These include the Surveyor's certificate, certificate of accuracy of timing equipment, certificate of accuracy of scale, contestant's entry form, Scorer's sheet, Timer's sheet and Inspector's report. The certificate of accuracy of timing equipment must contain the results of accuracy check performed on the watches or electronic timing

equipment by a qualified watchmaker or timing equipment expert within 72 hours after the record event and must show a 24-hour rate error of no more than 26 seconds. For manually wound

Timing devices, accuracy must be checked after 5 minutes of running and after 10 minutes of running. All speed runs shall be computed in statute miles per hour.

SECTION X - RULE CHANGES

A. Technical Rules

1. Subject to any rule freezes, Technical Rule Changes may be initiated in one of the following ways:
 - a. By a current registered equipment owner (rule changes must be for his/her class only)
 - b. By a group of current registered equipment owners in good standing from a specific APBA Offshore class (rule changes must be for that group's class only)
 - c. By the ORC
 - d. By the Technical Chairman
 - e. By the Chief Referee

Note: "Current registered equipment owners" shall be defined as those owners that are current members of APBA Offshore and have been members in good standing of an APBA Offshore class during the previous racing season and participated in at least 50% of the regular season races.

Registered equipment owners may not participate in requests for rule changes in more than one class unless they are actually campaigning more than one boat in separate classes, have paid equipment registration fees for multiple classes and meet the requirements of this paragraph.

2. Proposed rule changes shall be submitted to the Technical Chairman and/or Chief Referee for review and comment. Upon review of a proposed rule change, the Chief Referee and Technical Chairman shall draft the proposed rule change and submit it to the ORC for approval.
3. The ORC will review all written arguments for and/or against any rule change prior to voting. The ORC will approve rule changes based on what is best for APBA Offshore, the class and the sport of offshore racing.
4. Technical rule changes must be voted on and approved by a simple majority of the current ORC.
5. Technical rule changes may be made after May 1 will not become effective until January 1 of the following racing season. (For exceptions, see paragraph 7 following immediately below.)
6. Rule freezes may be lifted or changed only by a 100% majority vote of the current class members and a 100% majority vote of the ORC.
7. Upon approval by the ORC, any rule change shall become effective in accordance with these rules.
8. Approved rule changes shall be posted on the official APBA website and published in the next issue of Propeller magazine immediately upon approval by the ORC.

B. General Racing Rules

1. General racing rule changes may be initiated at any time in one of the following ways:
 - a) By the Chief Referee
 - b) By a current member or group of members in good standing of APBA Offshore
 - c) By the ORC
2. The ORC shall be responsible for approving all General Racing rule changes. ORC approval is accomplished by a simple majority vote of the ORC. Upon an affirmative vote by the ORC the rule changes will be submitted to the APBA Board of Directors for final approval.

APBA OFFSHORE EVENT SAFETY RULES

RULE 1 - GENERAL APPLICATION

The following Safety Rules apply to all APBA Offshore events and are in addition to all safety related rules set forth above in the APBA Offshore General Racing Rules.

RULE 2 - REQUIRED SAFETY FACILITIES

- A. **In General** -It shall be the Race Producer's responsibility to perform all safety functions and secure all necessary safety facilities in accordance with these rules and the Sanction Agreement.
- B. **Requirements** - Each Race Producer shall be required to provide the following:
1. **Safety Check-off Sheet** - Complete and return the APBA Offshore Pre-Race Safety Check-off Sheet to the Chair of the APBA ORC 30 days prior to the event.
 2. **Required Personnel** -
 - a. **Race Medical Director** - An emergency medical technician (EMT), or local equivalent (or higher), shall serve as the Race Medical Director. (Note: This is a minimum standard.)
 - b. **Emergency Rescue Personnel** - A minimum of 8 (eight) experienced and certified underwater dive/rescue personnel, appropriately equipped for course placement at the direction of the event referee.
 - c. **Emergency Medical Personnel** - A minimum of six (6) EMTs, and/or RNs, and/or Paramedics assigned for the Pre-Race Morning Physicals. All personnel are required to report to the posted location 30 minutes prior to the posted time of the physicals.
 3. **Required Facilities** -
 - a. **Ambulances** - A minimum of (1) properly staffed and equipped State Licensed Advanced Life Support (A.L.S.) ambulances for transporting injured APBA racers/crew to a designated hospital/trauma center. The exact number of ALS ambulances to be determined by the Medical and Safety Director in concert with the local race physician and local EMS.
 - b. **Medical Rescue Boats** - A minimum of four (4) Medical/Rescue boats on the racecourse at all times or more if conditions warrant as determined by the Chief Medical and Safety Director, 4 of which are A.L.S. equipped and staffed.
 - c. **Patrol and Tow Boats** - A minimum of ten (10) Patrol and Tow boats on the racecourse at all times or more if conditions warrant as determined by the APBA Offshore Chief Medical and Safety Director.
 - d. **Hospital** - An assigned trauma receiving hospital duly notified and equipped.
 - e. **Medical / Rescue, Tow and Patrol Boats** – LIFEJACKETS / BUOYANCY AIDS / SUITS – During all official times, all assistance / safety / rescue boat teams and all teams in support boats must wear lifejackets.

APBA OFFSHORE EQUIPMENT GENERAL SAFETY RULES

Note: Safety Rules are not protestable. Competitors may not protest other competitors with regards to non-compliance with APBA Offshore General Safety Rules.

Offshore emergency hand signals

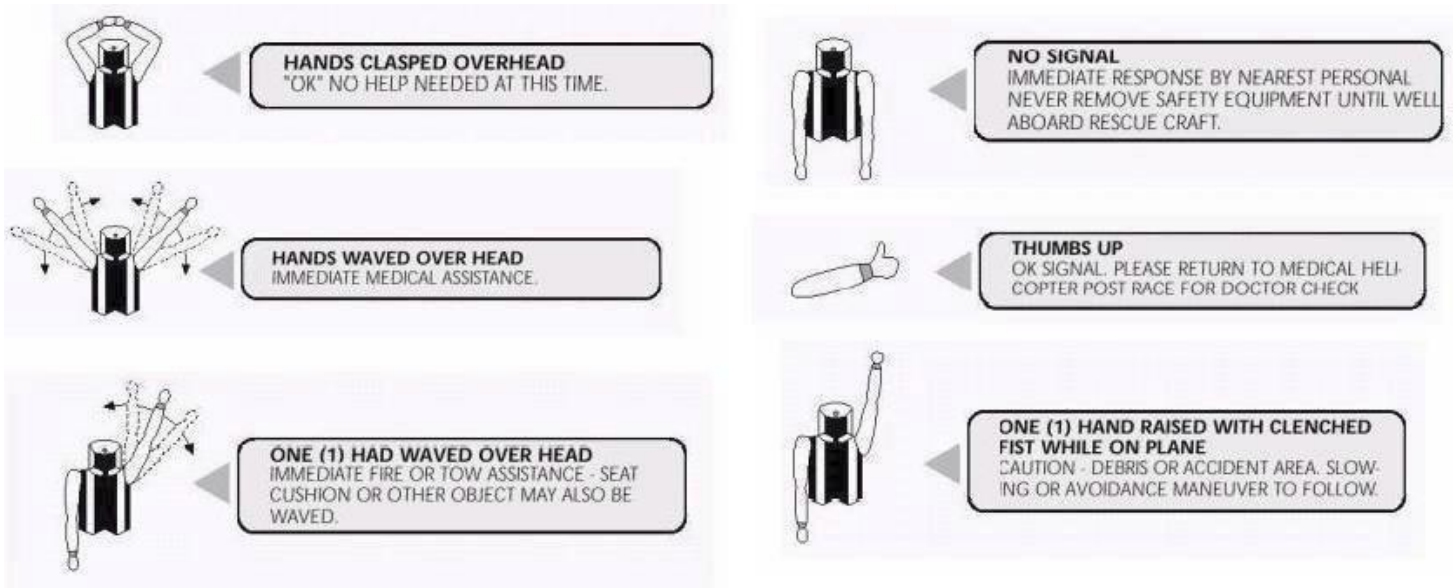

SECTION I - COCKPIT RELATED SAFETY RULES

RULE 1 - GENERAL APPLICATION TO ALL REGISTERED RACEBOATS

EXCEPT as otherwise specifically provided herein the following cockpit related safety rules apply to all APBA Offshore registered race boats.

RULE 2 - CANOPIED BOATS (Requirements for All Canopied Boats)

- A. **Lavin Guidelines** - The reinforced restrained cockpit systems used in all boats with seat restraints (open or closed cockpit) should be constructed in accordance with the latest Mark Lavin Foundation R.R.C./E.R.C. Cockpit Guidelines. ("Lavin Guidelines") It shall be the sole responsibility of the owner of the race boat to maintain a copy of the applicable Lavin Guidelines.
- B. **Non-compliance** - The Referee has the authority to deny entry to any race boat subject to these rules that has non-compliant cockpit safety systems. The Referee also has the authority to allow a non-compliant boat to compete provided that after consultation with the Referee, Competition Director and Chief Medical Safety Director he determines that the intent of the guidelines has been met and that the safety of the riding crew and fellow competitors is not jeopardized.

RULE 3 - ALL BOATS

- A. **Bolsters and Seats** - All registered race boats must have racing bolsters or racing seats with sufficient lateral support and structure to withstand the forces encountered in offshore powerboat racing. The bolsters and seats must be approved by APBA Offshore prior to being used in competition. Standard marine production seats are prohibited.

SECTION II - BOAT, TRAILER, PERSONAL AND RELATED EQUIPMENT SAFETY RULES

RULE 1 - GENERAL APPLICATION TO ALL REGISTERED RACEBOATS

EXCEPT as otherwise specifically provided herein the following cockpit related safety rules apply to all APBA Offshore registered race boats and competitors.

- A. **Ballast** - Removable ballast (sandbags, lead shot, etc.) must be enclosed in a permanently mounted box and lid capable of withstanding the rigors of offshore racing. All other ballast must be bolted or permanently attached to the hull.
- B. **Class A Safety Equipment** - Class A safety equipment is required for all race boats racing 10 or more miles offshore and shall be defined as follows:
1. An Offshore survival kit, or other similar kit to consist of:
 - a. Soft Plastic floatable-air tight container
 - b. USCG approved orange smoke flares
 - c. Orange 4' x 4' flag for emergency signaling
 - d. 3 oz. foil packets of drinking water or 12 oz. in soft plastic container
 - e. (10) Sterile 4" x 4" Gauze Pads (Zip Lock bag)
 - f. (3) Chemical cold packs
 - g. (6) 1" Band-Aids
 - h. (1) 1" x 5 yards Adhesive tape
 - i. (2) 5" x 9" ABD pads
 - j. (2) Rolls of soft gauze such as Kerlix or Kling
 - k. (1) Water sea drag anchor
 2. Two U.S. Coast Guard Approved fully charged fire extinguishers with metal pull rings and an indication gauge showing amount of charge secured in a position readily accessible to the crew.
 3. Minimum 100 feet of suitable tow line
 4. Inflatable dinghy with bottle inflation large enough to carry all riding members of the crew.
 5. One (1) Emergency in Position Indicating Radio Beacon (EPIRB) type "C" in working order is highly recommended.
- 6 Storage of Safety Equipment -**
- a. This Class A safety equipment must be stowed in an area of the hull, readily accessible to the cockpit, above or in a covered deck level compartment. It is highly recommended that the flares and E.P.I.R.B. be attached to the inflatable dinghy for access from cockpit and raft.
 - b. All safety equipment may be kept in a sealed, but easily opened container and the contents inspected at intervals of not less than six (6) months by a qualified APBA Inspector who shall affix a dated tag with his signature and an itemized list of contents thereof. This shall serve as verification that the contents meet official specifications.
- C. **Personal Safety Equipment - General** - At all APBA races sites, while operating any race boat, riding crew members must wear all inspected and approved required personal safety equipment anytime the boat is on plane before or after a race, while testing or during an actual race. During an actual race, if a boat breaks down, the riding crew members must continue to wear all required safety equipment until they are off-plane and safely inside the course or more than 250' from the outside course line. This rule shall be effective from the time a boat arrives at a race site until one (1) hour after the conclusion of the last race of the event. If an APBA registered boat is testing at times other than scheduled test times at a race site, or away from a race site, riding crew members are required to wear all required and approved safety equipment while the boat is on plane and operate said craft in a safe and prudent manner. Race boats testing on public waterways at times other than sanctioned test times must operate under normal rules of the road and are subject to all U.S. Coast Guard, State and local regulations. Violation of this rule shall subject the riding crewmembers and that entry to warnings, fines, and/or disqualification from that event or a future event.
1. **"Cool Suits"** - may contain any proven safe fluid or gas cooling agent other than Freon.
 2. **Cervical support devices** - may be worn in RRC's and ERC's subject to approval of the APBA Offshore Chief Medical and Safety Director.

3. **Footwear** - All participants and crewmembers must wear closed footwear when working in the pit area or riding in boats.
4. **Eye protection** - shall be mandatory for all racing and be constructed of shatterproof material. Eyeglasses shall not be accepted as eye protection.
5. **The Referee** - or Inspector may prohibit use of any equipment he deems unfit for service.
6. **Violation** - of safety rules will result in disqualification.
7. **Helmets** - Anytime an APBA Offshore registered race boat is being operated on plane or within 250' of an active race course at or away from a sanctioned event, all riding crewmembers must wear an approved helmet. If helmets contain radio communication speakers or earplugs, at least one crewmember must keep helmet on at all times in order to be able to communicate with race control.
8. **Helmets shall meet minimum rating specifications (SNELL, SFI, FIA or newer)** Helmets may display logos and/or decals on the lower 50% of the helmet for promotion purposes. Ultimately, all helmets are the responsibility of the wearer.
 - a. The upper half (½) of all helmets must be neon, fluorescent or international orange. The aforementioned area must be a single solid color with no graphics except names. Names may be painted on the upper half of the helmet provided that the letters do not exceed one (1") inch in height.
 - b. The Referee / Chief Medical and Safety Director shall disallow any helmet that he deems unfit for the rigors of offshore racing.
 - c. The Referee / Chief Medical and Safety Director have the authority to require any riding crew member to demonstrate that their helmet will function properly in the water. (safety test)
9. **Life Jackets** - Anytime an APBA registered race boat is being operated on plane or within 250' of an active race course at or away from a sanctioned event, all riding crewmembers must wear an approved life jacket.

General Requirements:

- a) All life jackets must have permanently affixed labels from the manufacturer or re-certifier stating the manufacturer's or recertifier's business or company name and the date of manufacturer or re-certification of the life jacket.
- b) All life jackets must be re-certified every three (3) years or sooner if they show signs of damage or abnormal wear. The Chief Medical and Safety Director's decision on more frequent re-certification shall be final.
- c) The Referee / Chief Medical and Safety Director shall disallow any life jacket that he deems unfit for the rigors of offshore racing.
- d) The Referee / Chief Medical and Safety Director have the authority to require any riding crew member to demonstrate that their life jacket will function properly in the water. (flotation test)

D. For the Restrained Cockpit

1. Category Type C (Note APBA Offshore allows only type C in restrained cockpits)
2. Lifejackets are approved for use in a restrained cockpit that employs a supplemental life support (air system) as required by APBA.
3. All straps and components of the life jacket must be present on the life jacket as manufactured.
4. The inflatable type C vest must be of independent twin cell construction and have 2 means of inflation with one being oral inflation.

5. When inflated, the vest must be capable of self-righting and floating an unconscious person with a minimum of 35 pounds of buoyancy.
6. No auto inflating, positive buoyancy or inflatable pouch type vests are allowed.
7. All life jackets when inflated must be international orange or yellow.

E. For the Unrestrained Cockpit

1. Category Type A is required for Performance Classes 6 and 7.
2. Category Type A-100 is required for Performance Classes 1-5. (Note: Category A-100 is also approved for use in Performance Classes 6 and 7.) Lifejackets must be designed for racing, including leg straps or thigh skirts securely attached to the jacket.
3. 70% of the upper portion of all lifejackets and skid collars must be orange or yellow in color.
4. There must be a minimum of 1/4" thickness of impact material covering the back and sides of the lifejacket.
5. All zippered seams must be covered by Velcro or similar safety tape.
6. Lifejackets shall be covered in a ballistic material (covering must meet or exceed the following specifications: Mil Spec Flay Nylon, Mil Spec C-476, Bright High Tenacity Nylon, 210 Denier, 3.6 oz per sq. yard, Count 62x50. Break strength 225 pounds warp, 152 pounds fill.)
7. Lifejackets must be capable of meeting USCG Type II flotation as specified in the UL standard 1123 Jacket must have a minimum flotation of 18 pounds with 10% flotation imbalance.
8. Lifejackets must be equipped with skid collars. The skid collar must contain a single piece of Ethofoam 900 (minimum 1/4" thick), which covers continuously from top inner edge of the jacket to a minimum of 2" past the base of the helmet when the lifejacket is worn in accordance with manufacturer's instructions, and the wearer is standing in an erect position looking straight ahead. The axial coverage shall be from 110 degrees to 250 degrees minimum, as measured from the center of the forehead. (approximately ear to ear) The outer covering of the skid collar shall be the same material as the outer covering of the life jacket or any other synthetic material, which is fungus, and mildew proof. Material covering the skid collar must be of equal or greater strength than the material used as the jacket covering. The thread used to stitch the skid collar to the jacket must also be fungus and mildew proof.

F. Suitability of Safety Equipment - It is to be expressly understood and as a condition of entry into an APBA Offshore event that APBA, APBA Offshore, the ORC or officials assumes NO liability in the selection or for the performance of any required safety equipment. Offshore racing is an inherently dangerous sport and no specific life jacket or helmet can eliminate all risks. Riding crewmembers are ultimately responsible for the selection of appropriate helmets and life jackets. The Referee/Medical Safety Director has the right to disallow the usage of any safety equipment he believes is unsafe or may inhibit rescue or extrication from a race craft.

G. Refusal of Entry - The Referee has the right to refuse the entry of any boat at an APBA Offshore event if he believes that said craft is unsafe, unmanageable or improperly designed or constructed so as to meet the demands of an offshore race.

H. Pit Areas - (See Section III, Rule 7)

I. Fueling - Race boats may be fueled / defueled in the hot pits under the direction of the local fire department or in the dry pits as long as local fire department regulations allow and the following requirements are met:

1. Spectators must be kept back a minimum of 50' from any boat being fueled / defueled in the dry pits.
2. Absolutely no smoking within 50' of the boat during the fuel transfer process.
3. Permanent fuel tanks in the boats and temporary tanks used to fill the boat must be grounded during fuel transfer process.
4. All transfer pumps, hoses, nozzles and temporary storage tanks must be UL or CG approved for use with gasoline, diesel or jet fuels. Absolutely no glass containers shall be allowed to contain fuel of any kind.

5. There must be at least one designated person standing by with a 5-pound dry chemical fire extinguisher at the point of transfer. The designated person may not have any other function. Fire extinguishers must have a minimum rating of 3A30BC and a functional gauge to indicate condition of charge.
6. Fire extinguishers must be re-certified and dated each year.
7. Fire extinguishers may not be more than 5 years old.
8. Team equipment (scooters, generators, etc.), priming fuel filters or anything else generally requiring less than 2 gallons of fuel are exempt from the above requirements.
9. Fuel may not be added or removed from race boats in the wet pits or on the racecourse for any reason. However, race boats may fuel at commercial marina pumps or land-based filling stations at any time prior to the start of the race. Violation of any portion of this rule shall subject the offender to fines from \$100.00 to \$1,000.00 and/or disqualification from the event. Competitors may report violations in progress to APBA Offshore Officials but may not file a protest against the violator. Fuel transfer violations must be observed by an APBA Offshore Official in order to penalize the violator.
10. **Fuel Cells** - are highly recommended for the storage of fuel in all race boats.

J. COURSE, PITS, BOAT SAFETY

1. **Allowed Race Times** - All racing shall be limited to the time period between official sunrise and 30 minutes prior to official sundown as forecast by NOAA.
2. **Marks of the Course** - All turns shall be made around turn buoys. All buoys shall be constructed so as to not damage a race craft accidentally striking said buoy. Boats alone may not serve as a mark of the course.
3. **Any boat that goes outside of official outside course markers must drop off plane and remain off plane until the boat returns to a point inside the outside course markers. Any boat that is outside of the outside course markers that does not drop off plane will be disqualified.**
4. **Pace Boats** - A minimum of two (2) and preferably three (3) pace boats is required at each APBA Offshore race site. Pace boats are to be at least 30 feet in length and capable of handling rough water at 50-70 mph. All pace boats must carry a minimum of 5 persons (driver, driver assistant, starter, flagman, flagman assistant). Boats shall be equipped with seating arrangements that do not hinder the starter and flagman while starting the race. If necessary, a fully equipped diver or EMS person may accompany the pace boat crew as a 6th crewmember. Absolutely no persons under the age of 18 are allowed on the pace boat. All persons on the pace boat must sign the insurance waiver. Under no circumstances may seats be sold or drawings held to allow spectators on pace boats. The decision of the Referee is final concerning all persons riding on the pace boats. All pace boat crewmembers must submit to APBA Offshore race day pre-race physicals.
5. **Craning of Boats** - Race boats utilizing the crane for launching must furnish their own single point lifting harness. Lifting harnesses shall be constructed or modified so as to lift the boat with a "bow up" attitude of 5-10 degrees for weighing purposes. Extensions to the front lifting straps may then be used to place the boat in a "bow down" attitude to facilitate loading onto a trailer as long as said extensions meet all lifting harness criteria. Lifting harnesses must be safety inspected at least once every three (3) years and a certification tag attached by a certified testing company. Lifting harnesses must be labeled with the team name, boat number and "front" and "rear" straps. **All persons are prohibited from riding on boats being craned into or out of the water.** Fines up to \$1,000.00 per incident may be levied.
6. **Tie Bars** - All boats running twin outdrives must have an external tie bar constructed and attached to withstand stresses created in offshore racing.
7. **Bilge Pumps** - All boats must have a minimum of two (2) bilge pumps. One of the bilge pumps shall be manually operated in case of electrical failure. Manual bilge pumps must be mounted and easily accessible in the engine compartment. Battery operated bilge pumps shall be automatic and wired independently of battery switches to allow operation even if battery switches are off.

8. **Fire Extinguishers** - All boats must meet current U.S. Coast Guard regulations for fire protection. It is strongly recommended that race boats be equipped with automatic on-board fire extinguisher systems over each engine. Auto-activated fire suppression systems are not allowed in the cockpit. Auto-activated fire suppression systems are confined to the engine compartment only. This system can be a single or multiple unit system, which must operate either automatically and / or manually. Manual overrides are highly recommended. For auto-activated systems, an early warning signal should be recognizable from the dashboard.
9. **VHF Radios** - All boats are required to have a permanently mounted 25-watt VHF radio capable of transmitting and receiving on channels 6 and 78A or such channels as designated by race control and announced no later than the final drivers' meeting. All boats shall monitor the designated communications channel for race control at all times while on the water.
10. **Cockpit Intercoms** - Interlocking connections pertaining to helmets and their respective intercom systems must be able to disconnect easily. Rigid or locking connections of any type are prohibited. All installations are subject to approval by APBA Offshore inspectors.
11. **U.S. Coast Guard Compliance** - All race boats must comply with current U.S. Coast Guard regulations.
12. **Bow Eyes** - All boats must be equipped with a permanently installed bow eye suitable for towing said craft.
13. **Drive-Line Shields** - All boats utilizing exposed input drive lines must have a protective shield covering each drive line. Protective shields must be constructed from 1/8" steel, aluminum or composite material (such as, but not limited to Kevlar, Carbon Fiber, etc.) of equivalent strength, adequately secured and cover the entire length and circumference (360 degrees) of the drive line plus all exposed universal joints.
14. **Kill Switches** - Must conform to Lavin Foundation Guidelines for restrained cockpits. All fuel and electrical kill switches as well as any manual fire suppression system switches must be marked by neon or fluorescent orange paint or decals over or around the switch. In non-restrained (open) cockpits, individual ignitions kill switches for connection to each riding crewmember are mandatory. Kill switch cords must not exceed four (4) feet. Spare kill switch caps are the only permitted method of emergency override and are mandatory. All competitors must be connected to an individual kill switch while the boat is on plane.
15. **Rear View Mirrors** - All canopied race boats must be equipped with a minimum of two (2) rear view mirrors. One mirror must be mounted on each side of the canopy so as to allow the driver and/or throttleman an unobstructed view behind the boat during competition. Rear facing CCTV shall not be considered a substitute for mirrors since electrical failure or equipment malfunction would leave a boat effectively blind behind the boat during competition.
16. **Deck Hardware** - All cleats and deck hardware shall be recessed, padded or constructed so as to not inflict injury to riding crewmembers or rescue personnel walking on the deck.
17. **Firewalls/Vents** - No holes shall be cut in firewalls between cockpit and engine compartment. In open cockpit boats, holes in deck must have a flame trap if the hole is one (1) foot or less from the crew.
18. **Propeller Safety** - All boats parked in the dry pits must have propellers removed or covered with prop covers so as to prevent injury to any persons. Spare propellers, installed on the hull, shall be covered by an inflexible protective shield.
19. **Grab Handles** - All boats must be equipped with closed end grab handles on the transom to facilitate rescue personnel or riding crew members boarding from the water.

20. **Non-Skid** - All boats must be equipped with non-skid material on the deck from the transom up to and around the canopy or cockpit. It is highly recommended that all catamarans equipped with emergency escape hatches have non-skid in the tunnel from the transom to the escape hatch.
21. **Trailer Identification** - All race boat trailers shall be permanently marked with the boat number on the forward half of the trailer. Markings shall be strongly contrasting in color and appear on both sides of the trailer.
22. **Footwear** - All participants must wear enclosed footwear in the hot pit areas or while competing in a race. It is strongly recommended that any race participant wear enclosed footwear in all pit areas.
23. **Medical Limitations** - Riding crew members are prohibited from competing in an APBA Offshore event with any type of artificial limb, pacemaker, pump, bag, cast, brace or splint unless written permission from the attending medical doctor is obtained and presented to the Chief Medical and Safety Director prior to the event.
24. **Chemical Limitations** - No competitor, crewmember, official or volunteer may participate in any APBA Offshore event while intoxicated or after consuming an alcoholic beverage, controlled or illegal substance. On non-race days, this rule shall be effective during "normal" hours of registration, race control and pit operation. On race-days from 12:01 am until one hour after the last race is completed or (if required) the entry has completed post-race technical inspection. Any owner, driver, throttleman, crew member, official or volunteer that has consumed any alcoholic beverage, controlled or illegal substance is ineligible to file, testify or participate in a post-race protest of any kind. However, minor consumption of ceremonial champagne is allowed only at the awards ceremony.
 - a. Intoxicated is defined as "under the influence of:"
 - 1) Alcohol
 - 2) Controlled or illegal substances including (but not limited to) narcotics, depressants, stimulants or hallucinogenic.
 - 3) Any substance, drug or combination of the above causing impairment of an individual's cognitive or physical functions so as to cause a danger to themselves or others.
25. **Intoxication** - Intoxication within any of the APBA Offshore defined pit areas by any participant (signee of the insurance waiver) will not be tolerated and will subject the entry with whom the offending person is associated with to penalties up to a \$1,000.00 fine and/or disqualification from the event.
26. **Canopy Lid Release, Cockpit Emergency Escape Hatch** - Canopy and escape hatch handles, inside and out, must be painted fluorescent orange or have a fluorescent orange background panel to identify them. Directional arrows must indicate the method and direction to open as recommended by the Lavin Foundation
27. **Engine Hatch / Cockpit Cover / Canopy Lids**- Inside engine hatch covers must be painted red, yellow, orange or a highly visible safety color for visibility. Hatch covers should be opened at all times when subject to search and rescue. Engine hatch covers should support at least 300 pounds. In open cockpit boats, when covered, the surface deck area, immediately behind the cockpit toward the transom, shall be covered by solid structure able to support 300 pounds of weight.
28. **Cockpit Safety** - It is **required** that there be no loose items within the cockpit of the boat during on-water operation. All items (dock lines, tools, water bottles, etc.) must be secured in such a way that they will not become flying missiles during any violent actions by the boat.
29. **Windshields/Windcreens** - In PRO-AM open cockpit boats, fitted windcreens or windshields shall be well supported and all exposed edges must be adequately padded. The use of glass is prohibited. Wind deflectors of any type must be shatterproof.
30. **Marine Compass** - All PRO-AM open cockpit boats must have a marine navigational compass installed in a highly visible position

31. **Racing Bolsters/Seats** - All classes require mandatory racing bolsters or racing seats; standard marine production seats are prohibited. Approval shall be based on lateral support and structure not padding.
32. **Rev Limiters** - All Performance boats must have rev limiters.
33. **Cockpit Emergency Air Systems** - All canopied race boats participating in an APBA Offshore event must be equipped with an on-board self-contained emergency air (scuba) system. No pure oxygen systems may be used. There shall be a minimum of one complete on-board emergency air system for each riding crewmember. The system may consist of an individual, or a multiple air source, capable of supplying the minimum emergency air requirements for each riding crewmember. As a minimum, the system shall consist of a scuba tank, mounting bracket, pressure gauge, air supply/escape supply hose, and a first and second stage regulator with a mouth piece and holder. An alternate full-time air system, or a nitrox system, with a face piece mask, or a unified helmet and face piece mask, meeting the minimum standards as prescribed herein is also acceptable. All systems shall be fully functional and turned on before starting a race or taking part in practice or testing. Spare air systems are not acceptable as substitutes for a cockpit emergency air system.
 - (a) **Tank - The tank** shall meet U.S. Department of Transportation (DOT) 3ALM or Transport Canada (TC) 3ALM scuba tank requirements to be approved*. Each tank shall be of sufficient size, with a minimum of a 19.0 cu. ft cylinder equivalency or more, for each member of the riding crew. Every cylinder must have been inspected and tested by either DOT or TC and meet DOT, TC, CGA (Compressed Gas Association), NIOSH and OSHA safety standards. The tank(s) capacity shall be large enough to supply each riding crewmember with a minimum of 15 minutes of supplied breathing air. These supply tank(s) can be in a single or multiple configuration. The tank(s) shall be securely mounted in an easily accessible area, in such a way that the hydrostatic test date and visual inspection sticker can be checked during the cockpit safety inspection. The tank(s) must have a minimum of 2800 psi residual pressure for either an aluminum or steel tank. A current visual (VIP) documentation and hydrostatic marking(s) shall be clearly visible at the time of inspection. The tank markings and VIP documentation shall be within current DOT or TC hydrostatic pressure testing standards to pass.
 - (b) **Tank Valves** - The tank(s) shall be equipped with DIN type screw in valves.
 - (c) **DIN Adapters** - DIN to yoke conversion adapters are not acceptable.
 - (d) **Tank Mounting Bracket** - The tank mounting bracket shall conform to the specific size of the cylinder and be manufactured specifically for scuba cylinder mounting. The bracket shall be securely mounted and capable of retaining the scuba cylinder in the event of heavy sea conditions, sudden accidents, or accidental inversion. The tank-mounting bracket shall be secured with stainless steel marine quality anti- vibration hardware, such as 18-8 or 316 stainless steel, with a minimum size of 3/8 inch. The hardware shall pass completely thru the mounting surface or interior wall that the mounting bracket is bolted onto. Large area washers shall be added on the reverse side for support or a backing plate shall be utilized when the mounting walls center is made of a soft-core material, (as opposed to a solid carbon fiber, resin and multi-layered wood, or multiple composite material, etc.)
 - (e) **Air Supply Hose(s)**: The air supply hose(s) utilized for all on-board emergency air supply systems, shall meet or exceed the minimum requirements for high- and low-pressure scuba hoses as prescribed by the DOT or TC. All air systems, regardless of the type, shall have an “emergency escape hose(s)” meeting the standard as described herein.
 - (f) **Emergency Escape Hose(s)** - Emergency escape hose(s), shall be of sufficient length to reach from the occupant's seat to a point above the chine (water's surface) on the opposite side of the boat. This can be measured by extending the hose and 2nd stage regulator or mask outside of the canopy to a position equal to the bottom of the opposite side sponson or vee bottom.
 - (g) **Escape Hose Storage and Deployment** - The emergency escape supply hose shall be stowed or secured in the cockpit in such a way that it may be completely deployed without resistance or

restriction when inverted during an escape. The hose must also be stowed so as to not entangle the crewmember and cause a hazard in the cockpit. This storage can be accomplished thru the use of Velcro straps or a Velcro closed bag, attached to a mounting point with Velcro which will release when pulled on after an accidental inversion. Metal snaps are not recommended.

- (h) **1st Stage Regulator** - The first stage regulator shall have a DIN screw in type connector to mate with the tank. All regulators must be serviced a minimum of once a year, or if the boat has been involved in a significant accident, been submerged, or has rolled over, or as directed by the Medical and Safety Director following an inspection where the proper function has come into question. Documentation of servicing shall be available at the time of the cockpit safety inspection.
- (i) **2nd Stage Regulator** - It is **required** that the second stage regulator be a balance model capable of equal functioning in the inverted position. System delivery mouthpieces that are part of the second stage regulator must be easily accessible to each competitor. The second stage regulator shall be secured in such a way that it will not become a flying object in the event of a sudden violent action by the boat. All second stage regulators must be serviced a minimum of once a year, or if the boat has been involved in a significant accident, or submerged, or rolled over, or as directed by the Medical and Safety Director following an inspection where the proper function has come into question. All current documentation of servicing shall be made available at the time of the cockpit safety inspection.
- (j) **Pressure Gauges** - There shall be a pressure gauge attached to the system to give an accurate pressure reading for the air supply tank(s). It is mandatory that the pressure gauge, or gauges for each independent system, must be visible at all times where at least one member of the riding crew can monitor the air pressure while the boat is under way. This will allow crewmembers to be aware of air leaks/loss of pressure in the emergency air system.
- (k) **Nitrox Systems or Full-Time Systems** - All Nitrox (NO) or Full-Time Air (FTA) systems shall meet or exceed the APBA Offshore minimum requirements for cockpit emergency air systems*. All race boats equipped with full time air systems must be capable of sustaining breathing for a minimum of (1) one hour for each riding crewmember. The Nitrox (NO) system shall consist of an enriched air supply system meeting or exceeding the requirements of the Enriched Air Nitrox Training and Certification Agency (A.N.D.I.), or the International Association of Nitrox and Technical Divers**, DOT and/or TC regulations. For either a Nitrox (NO) or Full-Time Air (FTA) system, a fitted mask face piece, or fitted mask face piece and helmet combination will be acceptable. The mask may also be equipped with an ambient air supply or ambient air port, and the ambient air port may be utilized until the demand for compressed air supply is required. All Nitrox (NO) or Full-Time Air (FTA) systems shall be activated prior to entry onto an APBA Offshore controlled racecourse or testing area.
- (l) **Savings Clause** - The final decision of any disputes involving the design, function, installation or reliability of an emergency air system, or the emergency air system components, shall be at the discretion of the APBA Offshore Medical and Safety Director and APBA Offshore ChiefReferee.

*Cylinder manufacturer specifications are available on request, or by viewing on the internet at Luxfer Scuba Products: <http://www.luxfercylinders.com/products/scuba/>, or at Catalina Cylinders: <http://www.catalinacylinders.com/tsd.html>, or Worthington Steel Cylinders at: http://www.worthingtoncylinders.com/high_pressure.html .

**A.N.D.I.: American Nitrox Divers International (or any Manufacturer recognized and endorsed Enriched Air Nitrox Training Agency with Oxygen Service requirements and procedures which parallel at least those currently practiced by A.N.D.I, or the International Association of Nitrox and Technical Divers. Further Internet info can be found at the following website links: <http://www.andihq.com/pages/mainpage.html> or at <http://www.iantd.com>

34. Carbon Monoxide (CO) Detectors - Due to the possibility of a Carbon Monoxide (CO) leak into the enclosed cockpit area of the boat, it is mandatory that all competing boats be equipped with a CO detector mounted securely in the cockpit. In addition to the audio alert has a visual activation signal (i.e. a bright red light, strobe, etc.) mounted where it is visible to the riding crew while the boat is underway.

35. **Safety Compliance** - In the interest of personal and life safety, and the promotion of good safety practices, the following guidelines for the enforcement of compliance with published APBA Offshore safety standards and practices are hereby incorporated.

- (a) Non-Life Threatening - For non-life-threatening safety issues (i.e. no non-skid, safety decalsetc.),
- (b) Life Threatening - For life threatening safety issues the Referee, Chief Inspector, and Chief Medical and Safety Director shall determine whether or not the boat will test and /or race at that event. There shall be no appeal from their decision.

Mandatory Medical Check After Accident - It is mandatory that all riding crew members involved in any accident requiring emergency rescue be transported to the emergency medical take-out area by the medical rescue boat and be checked out by paramedics or the race physician.

36. **Trailers** - All boat trailers must have permanent markings on the forward half of the trailer containing the boat number. The numbers must be displayed on both sides of the trailer and shall be strongly contrasting to the color of the trailer. Failure to properly mark trailers shall result in a fine and/or time penalty. The decision of the Referee is final and may not be appealed.

SLING SAFETY REQUIREMENTS

A. In General -

- 1. All slings used for lifting boats at offshore events must meet the following requirements. Slings not meeting these requirements shall not be used to lift boats at any Offshore events.
- 2. Homemade slings shall be proof tested annually to two (2) times the rated load of the sling by a commercial testing lab, sling certification center or sling manufacturer. The tester shall provide a certified copy of the test data sheet including the tester's company name, complete address and phone number.
- 3. Commercially manufactured slings must meet the following requirements:

B. Synthetic Webbing Slings - Selection, Use, and Maintenance (ASME B30.9c-2000) Scope: This Section applies to slings fabricated by sewing woven synthetic webbing of nylon or polyester type yarns, for the purpose of hoisting, lifting operations.

- 1. Sling Identification:
- 2. Marking Requirements:
- 3. Each sling shall be marked to show:
 - a) name or trademark of manufacturer
 - b) manufacturer's code or stock number
 - c) rated load for the types of hitch(s), and the angle upon which it is based
 - d) type of synthetic web material
 - e) sling identification shall be done by the sling manufacturer.
- 4. Maintenance of Sling Identification: Sling identification should be maintained by the user so as to be legible during the life of the sling.
- 5. Type of Inspection:
 - a) Initial Inspection: Before using any new, repaired, or modified sling, it shall be inspected to ensure that the correct sling is being used as well as to determine that the sling meets the requirements of this Standard.
 - b) Frequent Inspection: This inspection should be made by the person handling the sling each day the sling is used.
 - c) Periodic Inspection: This inspection should be conducted by designated personnel. Frequency of inspection should be based on:

- (1) frequency of sling use;
 - (2) severity of service conditions; and
 - (3) experience gained on the service life of slings used in similar applications.
6. Inspection Records: Written inspection records, utilizing the identification for each sling as established by the user, should be kept for all slings. These records should show a description of the new sling and its condition on each periodic inspection.
 7. Repairs:
 - a) Slings shall be repaired only by a sling manufacturer or a qualified person. When repaired, a sling shall be marked to identify the repair agent.
 - b) Temporary repairs of either webbing, fittings, or stitching shall not be permitted.
 - c) Repaired sling shall be proof tested to two times its assigned rated load before being put back into service.
 8. Removal Criteria: A sling shall be removed from service if damage such as the following is visible and shall only be returned to service when approved by a designated person:
 - a) missing or illegible sling identification.
 - b) acid or caustic burns;
 - c) melting or charring of any part of the sling.
 - d) holes, tears, cuts, or snags;
 - e) broken or worn stitching in load bearing splices;
 - f) excessive abrasive wear;
 - g) knots in any part of the sling;
 - h) excessive pitting or corrosion, or cracked, distorted, or broken fittings;
 - i) other visible damage that causes doubt as to the strength of the sling.

C. Synthetic Round Slings - Selection, Use, and Maintenance (ASME B30.9c-2000)

1. Scope: This Chapter applies to endless slings comprised of load bearing core(s) made of multifilament synthetic yarn(s), enclosed in a protective cover(s), for lifting purposes.
2. Removal Criteria: A round sling shall be removed from service if damage such as the following is visible:
 - a) missing or illegible round sling identification
 - b) melting or charring of any part of the round sling or fittings including damage from weld spatter;
 - c) holes, tears, cuts, abrasive wear, or snags that expose the core yarns of the round sling;
 - d) broken or worn stitching in the cover which exposes the core yarns;
 - e) fittings when damaged, stretched, cracked, worn, pitted, or distorted in any way;
 - f) round sling that are knotted;
 - g) other conditions including visible damage that cause doubt.

D. There are basic crane hand signals used to communicate with the crane operator that must be used by race and crew members allowed in the crane area.

E. Basic Crane Signals

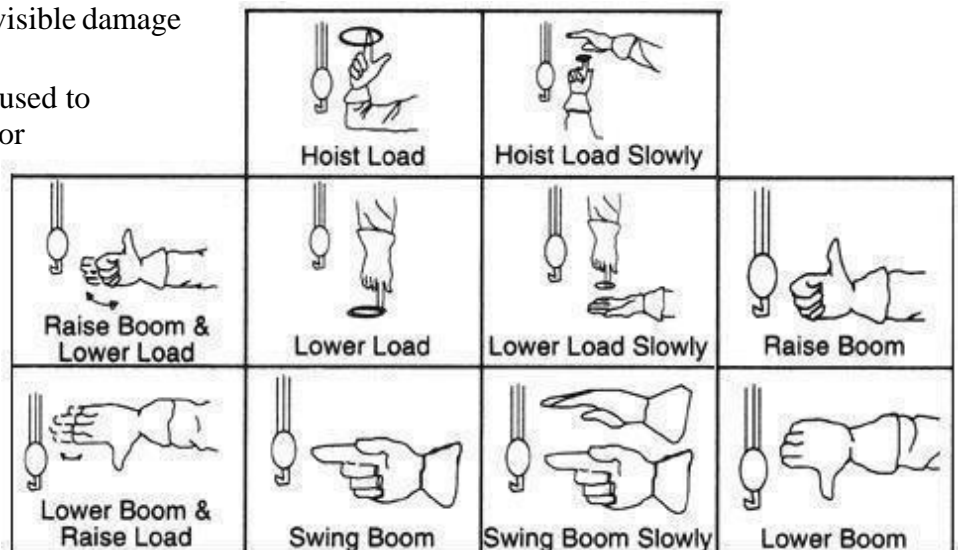

AMERICAN POWER BOAT ASSOCIATION
OFFSHORE TECHNICAL RULES
GENERAL REQUIREMENTS - ALL CLASSES

All APBA Offshore Class boats must strictly adhere to the following specifications. They also must observe the rules specified under their specific class headings. Any boat that is disqualified for a technical violation during the post-race inspection shall receive no prizes and zero points for the race.

1. **Interpretation** - If there is a disagreement or dispute about the APBA Offshore Technical Rules, the interpretation of the APBA ORC shall prevail. Decisions must be rendered in writing.
2. **Availability** - All boats as well as their parts must be (or must have been) for sale to the public at commercially reasonable prices.
3. **Enforcement** - To ensure competitive balance in all APBA Offshore Classes, APBA Offshore reserves the right to take whatever action necessary to enforce these rules. Boats and parts may be impounded for inspection purposes. APBA Offshore may prohibit the use of any part which can give a team an unfair advantage. Illegal parts become the property of APBA Offshore. If the illegal part(s) are not surrendered as demanded by APBA Offshore, the boat, the boat owner and all riding crewmembers will be suspended until the illegal part(s) are under the control of APBA Offshore. It is the responsibility of the owner or his designated representative to take all actions necessary that only APBA Offshore legal parts are used.
4. **Competitive Balance (Parity)** - APBA Offshore reserves the right to make adjustments at any time to these rules, or offer reduced requirements to older or non-competitive boats, if necessary, to maintain competitive balance.
 - a. All parity issues shall be directed to the APBA ORC and any adjustments shall be made by the Committee.
5. **Minimum Weight Compliance** - to be determined at the end of the race with the official APBA Offshore scale. The weight includes engines, residual fuel, drives, propellers, solid ballast and safety equipment as stated in the racing rules. Hull drain plugs must be removed, ballast tanks must be empty. The weight does not include crew, lifejackets, crash helmets and bilge water.
6. **Approved Boats** - All boats, and any modifications such as strakes, rails, etc., must be approved by the APBA ORC in writing.
7. **Boats Eligible for Racing** - As a general rule, all boats that were legal for competition in the 2004 APBA Offshore racing season in classes comparable to currently offered classes shall be considered legal in APBA Offshore. Final determination must be made on an individual basis.
8. **Serial Number** - Each hull must have a unique engraved serial number as required by law.
9. **Canopies** - All boats, except Bracketed Class boats, except where noted, competing in APBA Offshore events must be equipped with canopy safety systems, including canopy hatches (lids) fitted with positive open and positive close mechanisms, five-point restraint harness systems and on-board air systems. All newly constructed boats since 2005 must have a single canopy, seating two, side by side. The canopy must be located on the centerline of the boat.

Compliance with Lavin Guidelines - It is **required** that all canopied boats use structurally sound canopy safety systems that meet or exceed the latest Mark Lavin Foundation R.R.C. /E.R.C. Cockpit Guidelines. ("Lavin Guidelines")

Contact Information - The Mark Lavin Foundation R.R.C. /E.R.C. Cockpit Guidelines are available for \$25.00 per copy from the Mark Lavin Memorial Safety Foundation;
P.O. Box 116, Glen Arbor, Michigan 49636, Phone: 231-334-8184.
10. **Safety Hatch** - See class rules.
11. **Braking Systems** - Not allowed.
12. **Bolsters** - In all APBA Offshore classes racing bolsters or approved racing seats must be used.

13. Engine Compartment -

- a. Only engine compartments with ridged covers/hatches and a highly visible color underneath may be used.
 - b. All engine and fuel compartments need to be properly ventilated and meet all United States Coast Guard safety regulations.
14. **Exclusivity** - Exclusivity agreements for boats or any component used in APBA Offshore racing are not allowed.
15. **Exhaust** - Unless noted otherwise, engine exhausts must be water cooled. Water-jacketed manifolds must be employed from the engine outlet to the exit from the hull. "Cool Collar" exhaust designs are allowed. The exhaust exit from the hull must be located so that the exhaust fumes cannot affect the crew.
16. **Inspection Expense** - Any unusual inspection expenses incurred by APBA Offshore shall be the responsibility of the boat owner or his designee.
17. **Fuel** - At certain National or Bracketed Class Events there may be a minimum fuel purchase requirement. All boats entered in that event must purchase a minimum quantity of fuel from the official fuel supplier (fuel truck) on site at that event. Said required fuel purchase must be noted on the APBA Offshore Race notice for that event. This rule shall not be enforced for boats using 87-89-91 or 93 octane fuel if the price of the on-site fuel exceeds one dollar (\$1.00) per gallon more than the average price charged for the same octane fuel available from local major oil company stations (Exxon, Mobil, Chevron, Texaco, etc.). Any boat not purchasing the minimum required amount of fuel at a race site shall be fined an amount equivalent to the purchase price of the on-site fuel.

ALL gasoline-powered boats must install a "T" or other suitable fitting in the fuel system of each engine. The "T" or other suitable fitting shall easily facilitate fuel sampling before, during or after a race.

All classes are required to purchase the minimum quantity of fuel from the official fuel supplier but may purchase additional fuel (standard unleaded pump gasoline) from any retail public fueling stations or marinas. However, APBA Offshore reserves the right to specify one or more "outside" fuel suppliers at each race site in an effort to minimize confusion surrounding fuel testing. Extreme Turbine boats may purchase race or turbine fuel from local suppliers. Competitors may not supplement standard unleaded pump gasoline with any additives that will increase the oxygen content, octane rating or enhance the power output of the engine(s) in any way. Standard unleaded pump gasoline without additives is defined as unleaded fuel that meets the standards of petroleum-based fuel as defined by American Society for Testing and Materials (ASTM), designation: D4814, with the following clarifications. ("Supplement" is defined as physically adding (pouring) any substance other than standard unleaded gasoline into the boat's fuel tank or introducing any substance other than standard unleaded pump gasoline into the fuel system.)

- a. Specific gravity must be $\geq .715$ and $\leq .765$ at 60 degrees F.
- b. Maximum oxygen content is limited to 4.0% by weight.
- c. The only allowable oxygenates are ether, alcohols or other current EPA allowed oxygenators, as listed and characterized for oxygen mass fraction in ASTM D4814.
- d. The ethanol content must be less than 25% by volume.
- e. Oxygen bearing compounds are not allowed.
- f. Epoxides (i.e. propylene oxide) will not be considered as ether.
- g. Nitrogen bearing compounds are not allowed.
- h. Lubrication additives are permitted, provided the resulting mixture meets all other requirements of these rules.
- i. Unleaded gasoline may not be mixed with any commercial race fuel regardless of the source.
- j. The following substances (including but not necessarily limited to) are limited in amount by law or not allowed in standard unleaded pump gasoline: Acrylonitrile, Aminodiphenyl, Aniline, Benzene,

Benzidine, Beryllium compounds, Bromine compounds, Chloromethyl ether, Chlorine compounds, Ethylene oxide, Hydrazine compounds, Manganese compounds, Nitrobenzene, Nitrochlorobenzene, Nitrogen compounds, Nitrodiphenyl, Propylene oxide and Tert Butyl toluene. If concentrations of any of these substances greater than that allowed by the current EPA upper limits or any substances not listed as a part of commercial gasoline as defined by ASTM D4814 are found in a fuel sample, the competitor will be disqualified from the race and fined \$1,000.00. A second offense will result in a one-year suspension. A third offense will result in a lifetime ban from APBA Offshore.

- k. The use of compressed nitrous oxide as an engine performance enhancing product is prohibited in any class.

Accepted Methods of Fuel Testing:

- 1) Digitron Testing
- 2) Cerium Nitrate Reagent Testing
- 3) Water Solubility Test
- 4) Gas Chromatography (performed by an independent outside laboratory)
- 5) Any other method as recommended by independent outside laboratory or described in ASTM D4814

NOTE: Fuel contents are protestable. However, the loser in the protest shall be responsible for all outside laboratory expenses associated with the protest.

18. **Handrails** - Handrails (max. height of 6”), or hand holes, extending fore and aft must be fitted. Cables and lifelines are not allowed.
19. **Hull and Deck Measurement** - All race boats shall be measured from the top of the bow to the top of the transom on the centerline of the hull with the keel level to the ground. Swim platforms, rub rails, and any parts attached to the transom are not to be included in the measurement.
20. **Hull Extensions** - No extensions to meet minimum length.
21. **Lap belts** - not allowed.
22. **Single Point Lifting Harness** - required for all boats.
23. **Non-Skid** - required on deck surfaces - see APBA Offshore Safety Rules
24. **Aero-dynamic Devices** (such as wings or moveable deck surfaces) - not allowed.
25. **Trim Tabs, Tunnel Tabs** - a fixed or adjustable - legal. See individual class rules.
26. **Weight.**
 - a. Post-Race - All boats must report to the official APBA Offshore scale as required.
 - b. Penalties - 1 minute for each 100 pounds under weight. No scale tolerance.
27. **Air Conditioning**
 - a. Air Conditioning Allowed - Any air conditioning is allowed in all APBA Offshore Classes utilizing canopies or enclosed cockpits. An automotive type air conditioning compressor may be used if said compressor has passed a Certification Test for USCG Standards Title 33 CFR 183.410 / Anti Spark and Ignition Protection. Only the driver compartment may be cooled. In the event that engine seals are broken during installation, racers must get approval from the APBA Offshore Technical Committee.
 - b. Fuel or engine compartments may NOT be cooled in any manner with the air conditioning system.
 - c. Installation Approval - Installation of any air conditioning system must be approved by the APBA Offshore Chief Inspector or his designee.
28. **Anti-Stuff Bow Planes** - not allowed.
29. **Propellers -See Super Cat Class Rules.**
30. **No Forced Air Induction:** The air duct running from an external opening to the flame arrestor may not be completely sealed. Likewise, sealing or pressurizing of the engine compartment or engine air intake

is prohibited. Fresh air ducting is not allowed to be closer than 2” in any direction to the engine and/or flame arrestor.

31. **Ballast Tanks Allowed:** See class rules.
32. **Engine Hatches:** May be with or without scoops. Competitors may not raise their engine hatches from the time they have completed the race until the boat is presented for inspection to an APBA Offshore Inspector. During the race, engine hatches can only be raised for emergency repairs. Violators shall be disqualified unless the APBA Offshore inspection team can verify the case of emergency.
33. **Non-Compliance** - Competitors may not vote to allow a boat to run in non-compliance within their class.
34. **Changes:** APBA ORC may make any technical rule changes it deems necessary at any time without prior notice unless a class has voted to freeze the rules for that class. In that case, changes can only be made with the 100% concurrence of the current paid class members.

Championship Points

Championship Points will be scored the same as APBA points are earned.

CHAMPIONSHIP TIES

In the case of a tie in the overall Championship, the number of first places shall be considered, then the number of second places, etc.

In the case of the Championship still being a tie, the boat with the fastest average speed in any of the Championship races will be deemed the Champion.

PRE-RACE INSPECTIONS

1. All race boats entered in a sanctioned race are subject to a pre-race inspection by a UIM approved Chief Technical Commissioner
2. No race boat may be considered a bona fide entrant in a UIM race until such time as the Chief Technical Commissioner has passed and signed the official pre-race technical inspection form.
3. It is the responsibility of the Team Owner and the Manager to submit his team's equipment to the Chief Technical Commissioner for his inspection. If in the judgement of the Chief Technical Commissioner, a boat and/or safety equipment is unseaworthy, unsafe, or unmanageable, the non-compliance must be brought to the attention of the UIM Commissioner. If the UIM Commissioner determines that the condition cannot be rectified prior to the start of the race, then he shall have the right to prohibit the boat from competing.
4. The Chief Technical Commissioner shall examine each entry for compliance with all safety requirements and shall also visually inspect hull, propulsion, and engine for compliance with the class technical rules. The spirit as well as the letter of these rules shall be enforced equitably to all entrants.
5. Any new boat entry in these classes will be verified at its first event by the UIM Technical Commissioner. If successful, the boat will be allowed to participate in the Championship.
6. Any modifications to a boat shall be reported to the UIM Technical Commissioner and may require re-verification to ensure conformity. It is recommended that prior approval is sought before any modification is made.
7. Failure to inform the UIM Technical Commissioner of a modification will result in a penalty to be decided by the OOD and the UIM Commissioner. Alternatively, the UIM Technical Commissioner may require that

the boat be returned to its original specification to certify conformity.

UNIFORMS

All team members must be in uniform while attending drivers, briefings, parades, test / practice sessions, and anytime operating the race boat.

ENGINES

The only engine that can be used in the Catamaran race boats is the QC4V Class 1 race engine which has been approved and sealed by Mercury.

The only engine that can be used in the Vee Bottom race boats is the QC4V Class 1 race engine which has been approved and sealed by Mercury.

The objective of one design engine is so all boats have the same power and reliability. Any change done by the team to increase the horsepower will be seen as cheating and prohibited. The policing of the QC4V engines will be performed by Mercury Racing to assure engine parity and eliminate cheating.

GEARBOXES

Only the Mercury standard transmission that is included with the Mercury race engine is allowed. Nowhere in the drive train are there to be any:

- (a) multi speeds,
- (b) form of traction control, or
- (c) slip plates

DRIVE SYSTEMS: Catamarans

- (a) The only approved drive systems are as follows:
 - Mercury MK 6,
 - Mercury MK 8,
 - BPM drop box and torque tube,
 - SCS drop box and torque tube (quick change ratio),
 - Victory drop box and torque tube (quick change ratio),
 - Arenson drop box and torque tube, or
 - Buzzi Trimax drive
 - For Vee Bottom hulls only – any drive
- (b) The following are strictly prohibited:
 - No Traction control.
 - No steerable drives and rudder. (If you have a rudder you cannot steer with the drives as well. It must be one or the other).
 - No trim-able rudders.
 - No means of changing gear ratio without mechanical input (i.e. no cable or electric device to change).
 - Banned metals in the drive train and rudder assemble are as follows:
 - Hastello
 - Haynes
 - Inconel
 - Molybden
 - Monel
 - Titanium
 - Tungsten
 - Waspaloy
- (c) Race teams that have the quick-change gear ratio will be limited to 4 sets of approved propellers. Race teams that do not have the quick-change gear ratio can have an unlimited number of approved

propellers.

DRIVE SYSTEMS: Mono-Hull

- (a) Any drive propulsion system allowed
- (b) Any gear ratio allowed

TUNNEL TABS

Tunnel tabs shall be allowed with a weight penalty of 500 pounds.

PROPELLERS: Catamaran

As everyone has various kinds of propellers depending of where they have raced over the past few years, we would like to propose a 2 year plan so as everyone can use up their old stock of propellers and when purchasing new ones know they can use them in the future and they will be competitive based on these points. Please find as follows:

- Minimum weight 20 pounds
- Max diameter 18 inches
- Minimum diameter 16 inches
- Maximum rake 18 degrees
- Minimum rake 10 degrees

The thickness of the blades will be finalized in a study between Herring, Mercury and the ORC to determine a template with specific holes in it where the propellers can be measured. If another propeller manufacture wishes to enter into the class they must be approved by the ORC and be available to purchase to all teams at a competitive price. Boats with fixed gear ratios have an unlimited propeller choice. Boats with a quick-change gear ratio shall be limited to 4 sets of propellers.

PROPELLERS: Mono-Hull

- (a) Forged or Cast propellers allowed

BOAT WEIGHT - Catamaran

- (b) Minimum boat weight after race conclusion shall be 12,000 pounds for teams with no tunnel tab.
- (c) Minimum boat weight after race conclusion shall be 12,500 pounds for teams with a tunnel tab.
- (d) No water ballast tanks shall be included (tanks must be empty). There shall be no plumbing to the ballast tank. Ballast tanks must be empty at weigh-in and weigh-out
- (e) Bilges must be dry.
- (f) Weight without drivers and equipment.
- (g) A solid ballast must only be moveable manually and not controlled from the cockpit.

BOAT WEIGHT – Mono-Hull

- (h) Minimum boat weight after race conclusion shall be 10,000 pounds for teams
- (i) Ballast tanks are permitted but must be empty at weigh-in and weigh-out

BOAT LENGTH

- (j) Catamaran race boats must be minimum 37' and maximum 47' as measured by Inspectors for current race boats. Any newly constructed race boat must be a minimum of 40' and maximum of 47' as measured by the Inspector. The bottom of the transom (running surface) to the nose of pickle fork is the measured distance.
- (k) Vee Bottom race boats must be minimum 40' and maximum 50' as measured by the Inspector for current race boats.

INSPECTION

If a race team has doubt of another race team's integrity to these Rules, they may request a second inspection be

performed by an Inspector.

MEASUREMENT CERTIFICATE

A Boat is not allowed to take part in a local, National, or International race without a Digital Measurement Certificate as per UIM requirement. The certificate must be entered in the Class 1 Digital Log Book.

1. Any International or National race in which boats registered with a Data Log Book must be updated according to the events in the race. If the event is not covered by a UIM Technical Commissioner, the NA must upload the required information to the appropriate boats Data Log Book. If the NA is not capable of uploading the information, scanned copies of all the information and an entry list must be sent to the UIM Offices for uploading/updating the Data Log Books.
2. The Measurement Certificate has no expiry date, but must be updated following any of the below occurrences:
 - a. Change of Ownership
 - b. Change of boat dimensions and/or structure, or major repair after an accident or any other reason.
 - c. If an NA wishes to remeasure the boat, the NA must either upload the information to the boats Data Log Book or scan and send the signed measurement results to the UIM Offices for uploading/updating the Data Log Book.

RULES FLEXIBLE TO MAINTAIN COMPETITIVENESS

These initial Rules are designed to create and maintain a competitive class. If after the rough water race in Cocoa Beach, the flat-water race in Lake Ozarks, and the Sarasota race there exists an uncompetitive playing field we will revisit some of the Rules to be fluid and increase the competition amongst the boats.”

UIM COMPLIANCE

All Fees that may result in the race being compliant for UIM, will be responsibility of the CLASS ONE (1) USA Class. Contact OPA Registration two weeks prior to the race for a quote of said fees.

PROFESSIONAL FEES

All fees/costs that may result from Mercury Racing Inspections, Compliance, etc. will be the responsibility of the CLASS ONE (1) USA Class.

ENGINE HARDWARE

- (a) The required engine for a Catamaran is the Mercury Racing’s Competition 1100 QC4V
- (b) The required engine for a Vee Bottom is the Mercury Racing’s Competition 1350 QC4V
- (c) All engine hardware must be stock, as delivered by Mercury Racing
 - All hardware must be as per the official homologation document
- (d) Modification and/or relocation of factory engine sensors is prohibited
- (e) All engines will be mechanically sealed (tamper-proofed) by Mercury Racing Factory only
- (f) The following components will be sealed with safety wire and tamper-proofed locks.
Modification or removal of tamper-proof locks is prohibited.
 - Front cover
 - Crank encoder
 - Oil pan
 - Intake manifold
- (g) Relocation of the factory fuel pump and replacement of associated inlet and high-pressure outlet lines is permitted.
 - Unmodified, factory fuel pump must be used for fuel supply
 - If relocated, customer is responsible for extending power supply leads for the pump
 - If relocated, customer is responsible for sourcing/fabricating associated fuel lines

FUEL

1. 93 octane or less

PROPULSION CONTROL MODULES (PCMs)

- (a) Port and Starboard PCMs for use at a competition event are to be randomly distributed to competitors on the morning of each racing day. The serial numbers of each PCM and which boat they have been designated for shall be recorded.
- (b) Customer PCMs are to be used in all practice sessions.
- (c) Upon collection of competition PCMs, calibrations will be downloaded and checked by Mercury personnel for tampering.

CONTROLLER AREA NETWORK (CAN) DATA LOGGING

- (a) Mercury Racing will provide a CAN interface and several easy to install monitoring sensors to each race team on days of competition events.
 - Teams shall provide at least one available port on a SmartCraft junction box for use of the logger, and it must be readily accessible.
 - Teams shall provide a horizontal, flat area for mounting the data logger with provided hook and loop tape. Dimensions of mounting area TBD.
 - Teams shall provide a specified data logger to interface with Mercury's provided CAN interface module.
 - Data logger specifics *TBD*
 - The data logger will log PCM sensor data and additional redundant inlet air temperature (IAT) and manifold absolute pressure (MAP). These sensors will be serialized and tracked.
 - Redundant sensor locations TBD (IAT likely on back of #8 runner, MAP likely via a quick connect Legris line on cross over manifold)
- (b) Mercury to provide personnel for analysis of collected data, or will provide template files to sanctioning body officials to aid in analysis of the collected data.
- (c) Any devices attached to the Mercury SmartCraft bus shall be for measurement purposes only, such as data loggers and boat displays. Any attached devices are subject to inspection by sanctioning body officials. Purposeful modification of SmartCraft signals is prohibited.

POST-RACE INSPECTION

- (a) Up to top 4 finishers from each race are subject to a post-race inspection. Any or all of the following areas may be checked.
- (b) Engine electrical harness shall be visually inspected for modifications or repairs
 - No harness modifications allowed
 - Any repairs from incidental damage must be tracked in official log book(s) and approved by sanctioning body officials.
 - Repairs must be inspected and approved prior to a competition event.
 - Modification and/or relocation of factory engine sensors is prohibited
- (c) Camshaft Inspection
 - Precise location of top dead center (TDC) of an engine cylinder will be found with a degree wheel and piston stop.
 - Camshafts will be randomly checked for lift centerline locations relative to TDC.
 - Centerline locations for all cylinder's intake and exhaust cams to be maintained in a separate scrutineering document.
 - Camshaft lobe base circle diameters will be randomly checked for correct diameter. Lobes will be checked for correct form.
 - Mercury Racing will create and provide go/no-go tools for this inspection
- (d) Ignition Timing Advance Check
 - Precise location of top dead center (TDC) of an engine cylinder will be found with a degree wheel and piston stop.

- Check and mark or verify existing mark on crank encoder for TDC cylinder #1 (Mercury to provide improved timing pointer for accurately checking timing with a timinglight)
 - Mercury personnel will run a test to verify timing advance relative to TDC #1. This test will require operating the engine on a hose, in neutral, at a speed above idle.
 - Measured spark location to be within +/- 1° of Mercury factory recorded location
 - Spark advanced to be checked with specified timing light (TBD)
- (e) Visually inspect all hardware seals for tampering and serialization
- (f) Remove cross over manifold and inspect dummy throttle orifice size
- (g) Check that key up fuel pressure is under 420 kPa

SUPER CAT CLASS

All Super Cat Class boats must strictly adhere to the following specifications. They also must observe the rules specified under their specific class headings.

Class	Numbers	Length	Engine Type	# of Engines	Hull
SC	Numeric only	34' - 42'	Inboard	Twin	Cat

1. Interpretation - If there is a disagreement or dispute about the Offshore Technical Rules, the interpretation of the ORC shall prevail. Decisions must be rendered in writing.
2. Availability - All boats as well as their parts must be (or must have been) for sale to the public at commercially reasonable prices.
3. Enforcement - To ensure competitive balance in all Offshore Classes, the ORC reserves the right to take whatever action necessary to enforce these rules. Boats and parts may be impounded for inspection purposes. The race committee may prohibit the use of any part which can give a team an unfair advantage. Illegal parts become the property of APBA.
 - a) If the illegal part(s) are not surrendered as demanded by APBA, the boat, the boat owner and all riding crewmembers will be suspended until the illegal part(s) are under the control of APBA. It is the responsibility of the owner or his designated representative to take all actions necessary that only legal parts are used.
4. Competitive Balance - APBA reserves the right to make adjustments at any time to these rules, or require changes to individual boats, if necessary, to maintain competitive balance.
5. Minimum Weight Compliance - to be determined at the end of the race with the official scale. The weight includes engines, residual fuel, drives, propellers, solid ballast and safety equipment as stated in the racing rules. Hull drain plugs must be removed, Ballast tanks must be empty. The weight does not include crew, lifejackets, crash helmets and bilge water.
6. Boats eligible for racing - As a general rule, all boats that were legal in the 2012 and 2013 racing seasons in classes comparable to APBA classes shall be considered legal at APBA. Final determination must be made on an individual basis.
7. Serial Number - Each hull must have an engraved serial number as required by law.
8. Canopies - Compliance with the latest guidelines developed by Lavin and respective boat builders. Boats built after 2005 must have a single canopy, seating two, side by side. The canopy must be located on the centerline of the boat.
9. Safety hatch - Catamaran Boats built after 2005 must have a bottom escape hatch located in the tunnel of the boat. Existing boats do not have to be retrofitted.
10. Braking Systems - Not allowed.
11. Engine Compartment - Only engine compartments with ridged covers/hatches and a highly visible color underneath may be used.
 - a) All engine and fuel compartments need to be properly ventilated and meet all United States Coast Guard safety regulations.
12. Exclusivity - Exclusivity agreements for boats or any component used in racing are not allowed.
13. Exhaust - Unless noted otherwise, engine exhausts must be water cooled. Water-jacketed manifolds must be employed from the engine outlet to the exit from the hull. The exhaust exit from the hull must be located so that the exhaust fumes cannot affect the crew.
14. Inspection Expense - Any unusual expenses incurred by APBA or the conducting APBA club shall be the responsibility of the boat owner or his designee.
15. Fuel - Any additives whatsoever are strictly prohibited. Fuel will be tested. In the event that a competitor is found to have additives in the fuel, they will be disqualified from the event. All boats are required to use pump grade fuel with a maximum octane rating of 93.
 - a) Electric fuel pump shutoff - must shut off when the kill switch is engaged.

- b) Through deck fuel fills - as specified by United States Coast Guard regulations must be used. All fuel must be carried in secure tanks that are vented overboard. Transfer of fuel is not allowed during a race, except via properly installed fuel lines that supply fuel to the engines. Fuel tanks and fills must be grounded.
- 16. Handrails - Hand rails (max. height of 6”), or hand holes, extending fore and aft must be fitted. Cables and lifelines are not allowed.
- 17. Approval of Equipment -
 - a. Boats and engines must be approved by the conducting club’s Technical Committee. All hulls must be produced from a dedicated mold. One of a kind boats are not allowed. All changes to the dedicated mold must be approved by APBA.
 - b. Engines must be based on an automotive block sold through normal distribution channels and available to the general public. Gasoline type engines only.
- 18. Hull and Deck Measurement - All race boats shall be measured from the top of the bow to the top of the transom on the centerline of the hull with the keel level to the ground. Swim platforms and any parts attached to the transom are not to be included in the measurement.
- 19. Hull Extensions - No extensions to meet minimum length.
- 20. Single Point Lifting Harness - required for all boats.
- 21. Non-Skid - required for walking on deck surfaces from aft and around cockpit.
- 22. Aero-dynamic devices (such as wings or moveable deck surfaces) - not allowed.
- 23. Trim Tabs, Tunnel Tabs - either fixed or adjustable - legal.
- 24. Weight -
 - a. Post-Race - All boats must report to the official race scale as required.
 - b. Penalties – Underweight boats will receive last place points. No scale tolerance.
- 25. Air Conditioning -
 - a. Air Conditioning Allowed - Air Conditioning is allowed in all APBA Classes utilizing canopies or enclosed cockpits. An automotive type air conditioning compressor must be used. Only the driver compartment may be cooled.
 - b. No cooling allowed - Neither fuel or engine compartments may be cooled in any manner through the air conditioning system.
- 26. Anti-stuff bows planes - Not allowed.
- 27. Propellers -
 - a. Propellers must be of the type approved by APBA.
 - b. Manufactures may apply to APBA for approval.
 - c. Propellers must be manufactured from stainless steel castings. No forged, billet, or other propeller types. No exotic alloys such as Magnesium or titanium are allowed.
 - d. Propellers may be modified. Blue printing, lab finishing, polishing, grinding, welding, machining etc. are allowed. All propellers are limited to a minimum thickness required for prop integrity. Propellers must be intended for sale to the public at commercially reasonable prices. Propellers must be available to all racers within 4 weeks.
- d. Propellers thickness specifications for Super Cat are approved. Refer to table.

PROPELLER INSPECTION PROCEDURE AND PROPELLER SPECIFICATIONS

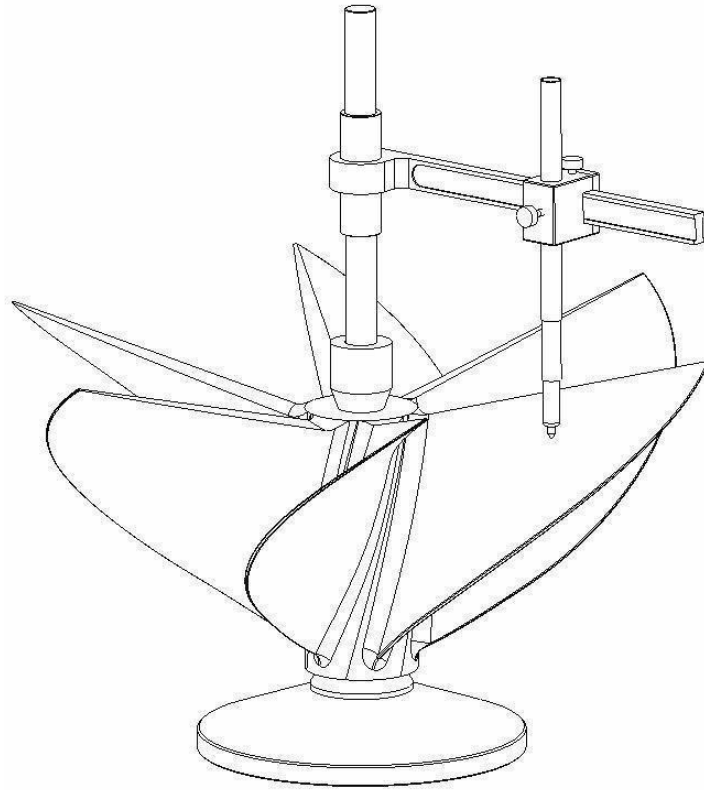

ITEM	DESCRIPTION
1	Base
2	Lower support cone
3	Upper support cone
4	Post
5	Arm
6	Guide block
7	Pen holder tube
8	Marking pen (Sharpie with tip modified to mark at steep angles)

MERCURY RACING VI SSM CLEAVER PROPELLER MINIMUM THICKNESSES

Table 1. Inspection Radii

Propeller Diameter (inches)	Inspection Radii (inches)		
	Root	Middle	Tip
15	2	4 1/4	6 1/2
15 1/4	2	4 5/16	6 5/8
15 1/2	2	4 3/8	6 3/4
15 3/4	2	4 7/16	6 7/8
16	2	4 1/2	7
16 1/4	2	4 9/16	7 1/8
16 1/2	2	4 5/8	7 1/4
16 3/4	2	4 11/16	7 3/8
17	2	4 3/4	7 1/2
17 1/4	2	4 13/16	7 5/8
17 1/2	2	4 7/8	7 3/4
17 3/4	2	4 15/16	7 7/8
18	2	5	8

Table 2. Super Cat VI SSM Propeller Blade Thicknesses

(Minimum allowed at each measuring point)

Inspection Radius	Leading Edge		Trailing Edge	
	Distance from Edge (in)	Minimum Thickness (in)	Distance from Edge (in)	Minimum Thickness (in)
Root	1 3/8	0.283	1 1/2	0.475
Middle	1 1/2	0.182	1 1/2	0.302
Tip	1 11/16	0.115	1	0.130

28. No forced air induction: The air track running from an external opening to the flame arrestor or carburetor may not be completely sealed. Likewise, sealing or pressurizing of the engine compartment is prohibited. Fresh air ducting is not allowed to be closer than 2" to the engine and/or flame arrestor. The engine compartment vent area must be equal to, or larger than the area of the airscoop(s).
29. Ballast tanks NOT allowed: Ballast tanks are not allowed in Super Cat. Transfer of any ballast (including fuel) is prohibited in any manner while under way or remotely. Once on the race course, racers may stop and physically move weight bags manually if it is safe to do so.
30. Engine hatches: May be with or without scoops. Competitors may not raise their engine hatches from the time they have completed the race until the boat is presented for inspection. During the race, engine hatches can only be raised for emergency repairs. Violators shall be disqualified unless the race committee inspection team can verify the case of emergency.

Technical Rules - Super Cat Class

All Super Cat (SC) Class boats must strictly adhere to the following specifications. Please also refer to the rules pertaining to all offshore classes.

BOAT SPECIFICATIONS:

Hull type:	Catamaran
Length minimum:	34' 0"
Length maximum:	42' 0"
Beam maximum:	12'
Tunnel width maximum (measured at keel):	66"
Height minimum (keel to deck):	48"
Weight minimum:	9500 LBS

ENGINE SPECIFICATIONS:

1. General:

Displacement, maximum	510 CID
Displacement, minimum	495 CID
Compression ratio, maximum	9.5:1 as determined by APBA approved whistler device. At its discretion, APBA may require cylinder head removal for actual cc measurement.
Engine Rotation	Standard rotation only. Counter rotation engines not allowed

2. Engine Blocks:

Cast iron	Only cast-iron blocks are approved. Billet main caps are approved.
GM Big Block Chevy type	Blocks with 9.8" or 10.2" deck heights approved
GM Big Block Chevy type	Blocks manufactured by General Motors, World Products (Merlin), and Dart Machine are approved.
Other blocks	Must be approved by APBA
Cylinder sleeves	Allowed for repair purposes
Cylinder bore centers Maximum bore size	Must remain in OEM location. 4.605"

3. Internal Components:

Materials allowed	Crankshaft, connecting rods, pushrods and wrist pins must be made of steel.
Materials, not allowed	Titanium or any other materials
Wrist pins	Minimum .990" inch diameter
Pistons, allowed	Forged Aluminum
Pistons, not allowed	Titanium, or any other exotic material
Crankshaft Stroke	Maximum stroke is 4.00 inches. There is no minimum stroke. Maximum Bore is 4.605 inches.
Single plane crankshafts	Not allowed. Crankshaft throws must be timed according to OEM specifications

4. Cylinder Heads:

Cylinder heads	Must remain in OEM location.
Approved heads	Big block Chevrolet Brodix # SP BB - 2 PLUS, as cast and provided by Brodix with the following allowed modifications. No other head is allowed.
CNC	Spec heads may have CNC or hand shaped chambers and Intake port may be matched not to exceed 3/4 inch measured from the intake manifold surface.
Blending	Grinding or blending of CNC valve work or CNC chamber work is allowed Blending not to extend more than 1/2" inch from the base of the seat insert into the ports.
Grinding and Polishing	Except in the combustion chamber and the areas immediately adjacent to the valve seat, no grinding or polishing allowed anywhere.
Resizing of ports	No change or alteration of the shape or size of the ports or runners allowed. Addition of any material to ports, bowls, or runners is prohibited.
Cylinder head repairs	All major repairs that require welding must be performed by Brodix.
Milling	No angle milling of head surface.
Head bolts	Additional head bolts legal. Two head bolts per cylinder head are legal installed through bosses in block in the lifter valley to the underside of the head.

5. Valve System:

Number of valves	Two valves per cylinder operated by pushrods. One camshaft located in the block, OEM location.
Intake valves, allowed:	Stainless steel, or titanium
Intake valves, not allowed	Pneumatic, hollow stem, ceramic valves
Exhaust valves, allowed	Stainless steel, Super Alloy, or Inconel
Exhaust valves, not allowed	Titanium, any other
Valve stem diameter, minimum	11/32"
Variable cam timing	Not allowed
Maximum gross cam lift	0.720-inch, zero lash, measured at the valve
Camshaft	Must remain in OEM location
Lifter bores	May not be changed from OEM location
Sleeves	May be used. OEM lifter bore location may not be changed
Lifters	Pushrod must ride in center of lifter. No offset lifters.
Pushrods	Must remain in OEM location
Valve seats and guides	Must remain as manufactured and in OEM positions.
Valve guides	Not to be cut down, shortened, tapered, or reshaped
Valve angle	As manufactured
Valve head diameter, maximum	Intake 2.300", exhaust 1.900"
Valve spring cooling	Allowed with internal engine oil
Offset head guides	Not allowed. Head mounting location may not be altered.
Spring Retainers	Except as stated above, any material and design may be used
Rocker Arms	Except as stated above, any type or design legal
Rocker stud girdle	Legal

6. Intake Manifold:

Approved intake manifolds	Brodix part numbers HV 2001-A and HV 2005-A. Other brands are also allowed as cast from Edelbrock, World, and Dart. Fabricated intake manifolds are not allowed.
Modifications	Not allowed
Welding	Not allowed
Porting	Allowed for 1 ½” closest to the cylinder head
Carburetor spacers	Maximum 2.5”
Intake Manifold	90-degree angle between deck surface and intake manifold surface not to be altered.

7. Induction System:

Number	Only one carburetor per engine
Approved type	Any Holley “Dominator” 4500 series carburetor
Fuel injection	Not allowed
Blueprinting	Allowed

8. Exhaust System:

Materials	Cast or fabricated allowed only
Length	Maximum 15-1/2” individual primary runner length, measured at centers of any runner, cylinder head port to common collector.
Mercury/CMI Headers	-OR- The CMI “Sweeper” style header provided as OEM header on the Mercury Racing 525EFI, 600SCI, and 700SCI, and the CMI GEN-X “Sweeper” replacement header are allowed.
Length to include	Any adapters, or wedges from the exhaust ports to the common exhaust collector
Shape	Any common collector shape allowed
Exhaust pipes	“Y” and “H” allowed
Cooling	Exhaust system from engine outlet to point of exit from hull or deck must be water-cooled by water jackets

9. Transmissions:

Single speed	Allowed. Must be capable of neutral, forward and reverse
Multi speed	Not allowed
Power	Must be derived from main engines

10. Lubrication:

Wet sump	Wet sumping and internal oil pumps allowed
Dry Sump	External oil pumps / dry sumping allowed. Not more than three scavenging pump sections allowed.
Filter screens	Allowed. May not restrict the return of oil to the crankcase. Flush mounted only.

Intake valley	As cast only. No damming, no raised sections, no alterations whatsoever. All oil must return internally through original passages. Returning oil externally to the crankcase oil pan by any other method is prohibited.
---------------	---

11. Ignition:

Distributor	Must remain in OEM location.
Spark distribution	Distributor rotor / cap only
Electronic ignition	Allowed
Crank triggered ignition	Not allowed
Belt drive ignition	Not allowed
Coils	Limit one ignition coil per engine.
Back-up ignition	Are NOT allowed
Rev limiter	RPM limited to 7000 RPM. A G2 Data Logger must be installed and maintained to monitor the RPM level during the race. The RPM level during the entire race must be verifiable on the Data Logger by the event inspectors during post-race inspection. The wiring harness of the system must be readily accessible for inspection by event inspectors. No dual systems or ignition components allowed. The RPM level during the entire race must be variable on the data logger by the APBA inspector upon completion of the race.

12. Outdrive:

Approved type	Mercury Racing SSM VI The skeg thickness must comply with the inspection template.
Dropdown box	Not allowed
Shaft drives	Not Allowed
Drive modifications	Not allowed-Must remain internally as produced by Mercury racing using all gears and shafts.
Gear reduction, SSM VI Propeller aerators	1.61:1 (1.607:1) is the only approved gear ratio for Super Cat Allowed

PROSTOCK V CLASS (SUPER VEE LITE)

The **PROSTOCK V** class is designed for racers that want the safety of being in an enclosed canopy while enjoying deck to deck competition against similar boats with identical power. APBA would like to see this class grow and thrive as it's an excellent step up for our current teams racing in the speed bracket classes. APBA's goal is to stabilize and grow the **PROSTOCK V** class by enforcing a set of rules that will allow multiple hull manufacturers to compete on a level playing field. In order to achieve our goals, APBA will use several methods to achieve parity in the class, which will allow older hulls to remain competitive against newer hulls that might be more efficient in a straight line.

The class known as **PROSTOCK V** will divide equally whatever money has been slotted to the class. Any boat that is at the race site, registered and attempts to race, qualifies for the purse. First, second and third place boats will receive the trophies if awards are given out.

Technical Rules – PROSTOCK V

If anything is not listed in these technical class rules, you should assume the answer is NO. APBA Officials may interpret these rules, based on circumstances at the time.

Engine Build Requirements – ProStock V Class

1. ProStock V team can have their engine rebuilt by any builder of their choice. APBA **MUST** be notified in advance
2. After the rebuild, the engine **MUST** be delivered to an APBA Inspector for inspection/Dyno, to determine it is legal for competition.
3. If the engine is determined to be legal, it will be sealed and returned to the team owner. There are no alterations allowed to the 525-engine package.
4. Maximum cubic inch limitation of 509 cu in
5. Dyno sheets will remain with the APBA Inspector
6. A standard of 560 HP will be the benchmark plus or minus 20 hp. If an engine falls short of the benchmark the team will be notified prior to sealing.
7. APBA at its discretion has the right to Dyno any team's engine at any time. If found out of spec, the team will lose all points for that season, and will be disqualified until such time that the engine is brought back into spec.
8. All internal parts must remain as OEM spec.
 - For example, if a team uses an aftermarket crankshaft, it must meet OEM spec as far as weight, stroke, journal size, external balance, keyway location etc.
9. All Camshafts must remain the original Mercury OEM part.
10. Overbore not to exceed .030 in the engine block, any standard deck standard bore block can be used.
11. No alterations to the cylinder heads will be allowed. surfacing to the deck of the head is allowed, but the compression must remain under 8.7.
12. Fuel system and intake plenum must remain as produced by Mercury Marine.
13. In other words, the intent here is to allow the teams to be able to build their own engines as long as they remain as a stock 525 engine package. In order to maintain parity in the ProStock V class.
14. The cost for inspection by an APBA Inspector will be \$800.00. The Dyno time will also be \$800.00.

ProStock V GPS Unit

All ProStock V boats are required to run a V-Box GPS System. V-Box is the only system that is legal for use in ProStock V. (*see section for "OFFICIAL GPS UNITS"*)

Hull Specifications: All **PROSTOCK V** teams must adhere to the following specifications along with the general rules pertaining to all offshore classes.

1. Any new boat racing with APBA for the first time must notify APBA at least 60 days prior to the race they plan to attend. The boat will have to pass an inspection and sea trials prior to qualification to race with APBA. All bottom modifications allowed, but Parity will be addressed at this time and throughout the season for all teams.
2. Extensions to the deck of the boat both fore and aft are allowed. Any additions will be included in the overall measurement of the hull.
3. Hull extensions may not be used to meet minimum length.

Weights and Dimensions:

Hull type: Monohull

Length minimum 26' 0"

Length maximum - Bow to Transom - 30' 0"

Length maximum Overall: 32' 0"

Beam minimum: 6' 6"

Beam maximum: 8' 6"

Number of Engines: 1

Single Step Hulls Weight minimum, Bravo, Imco drive 4750 lbs.

Twin Step Hulls Weight Minimum, Bravo, Imco drive 5000 lbs. at first race - adjusted for parity by APBA.

Triple Step Hulls Weight Minimum, Bravo, Imco drive 5250 lbs. at first race- adjusted for parity by APBA.

Penalties: Under Weight: This will result in a last place finish for the day. Multiple Offenders. Place will be determined by amount of weight under. No scale tolerance.

Canopies: All boats must be equipped with canopy safety systems, including canopy hatches (lids) fitted with positive open and positive close mechanisms, side by side only. No inline seating allowed. Five-point restraint harness systems and on-board air systems are required.

Single Point Lifting Harness: Required for all boats

Braking Systems: Not allowed

Grandfathered Boat(s)

27' Activator, hull # _____, is approved for competition at 4550 pounds.

32' Bad Boy, hull # _____, APBA has amended the length rule in the **PROSTOCK V** class to allow the 32-ft. Bad Boy hull # _____, to compete in the PROSTOCK V class indefinitely. This hull

and only this hull will be allowed to compete within the class. The hull in question was manufactured in 2007 when the class rules allowed a 32-ft. boat to compete within the class. The length rule has since been changed to 30 ft. Reason for the decision is based upon date of manufacture, and single step hull design. APBA has every intention of maintaining the integrity of the **PROSTOCK V** class and felt that this particular hull would be an asset to the class and fall within the performance basis of the other **PROSTOCK V** hulls. If this hull is ever damaged beyond repair, another cannot replace it unless shortened to the 30-ft. length limit rule. Although there are no penalties added to this boat, APBA reserves the right to adjust weight if necessary, to obtain and control parity within the class. The boat will have to meet all other class restrictions that exist within the **PROSTOCK V** rules.

- 30' Lavey Craft, hull # _____, which is a twin stepped hull, is approved for competition at 4750 pounds.

4. Aero-dynamic Devices (such as wings or moveable deck surfaces) - not allowed. Anti-Stuff Bow Planes- not allowed.

5. Non-Skid - All boats must be equipped with non-skid material on the deck from the transom up to and

around the canopy.

6. Engine Compartment - Only engine compartments with ridged covers/hatches and a highly visible color underneath may be used.
7. Exclusivity - Exclusivity agreements for boats or any component used in racing are not allowed.
8. Handrails - Handrails (max. height of 6”), or hand holes, extending fore and aft must be fitted to deck of hull. Cables and lifelines are not approved.
9. Approved Inboard Production Race Engine: The approved engine is the Mercury 525. All engines may be allowed with the original Mercury seal. All rebuilds MUST be sealed by an approved APBA Inspector.
10. NO MODS TO STOCK ECU. The conducting club reserves the right to swap ECUs with any boat at any time. (Team will be allowed time to test new ECU to make sure it works properly.)

Must Whistle Test below 8.7:1 compression ratio.

- a) No aluminum flywheels
- b) All sensors must remain OEM
- c) RPMS are limited at 5450 for Mercury Engines

No Forced Air Induction: The air track running from an external opening to the flame arrestor may not be completely sealed. Likewise, sealing or pressurizing of the engine compartment or engine air intake is prohibited. Fresh air ducting is not allowed to be closer than 2” in any direction to the engine and/or flame arrestor. Stock Mercury Racing Flame Arrestor or Stock HP3 arrestor must be complete and in place, (no holes drilled)

11. Approved Exhaust System Specifications: Engine Allowed Exhaust Manifolds 525EFI

ENGINES	Allowed Exhaust Manifolds
525 EFI	Mercury Style CMI Header, Only the CMI sport tubes are legal for competition (part #13012), CMI straight back sport tube (part # 13020), CMI Gen-X Header or Innovation Marine Tractor Style Header

12. The header measurement from the header flange top that bolts to the cylinder head, to the header collector flange bottom is 7.5”

Exhaust tips	Any elbow top, tail pipe or exhaust tips
Tail pipes	Any length - Individual tail pipes required; H & Y tail pipes not allowed
Tail pipe exit	Through gunnel, deck, or transom, not to extend more than 12” beyond transom
Cooling	Water Jacket
Dry Tail Pipes	Allowed

13. Rear engine mounts are allowed.
14. Jack Shafts are allowed, max dist. 15”.
15. Cooling Water: Cooling water must come through outdrive pickups, the use of a hull pickup is also permitted, the drive pickups must stay open. The cooling water flow to the exhaust system must remain in production configuration. Engine cooling water must travel from the exhaust elbow or tail pipe into the exhaust, or to a thru hull fitting. Water may not be diverted for exit elsewhere. APBA may approve other exhaust installation hardware if required to fill ballast tank
16. Ballast Tanks are approved.

17. Fuel Testing: ALL **PROSTOCK V** boats must install a “T” or other suitable fitting in the fuel system of the engine. The “T” or other suitable fitting shall easily facilitate fuel sampling before, during or after a race. All **PROSTOCK V** class boats may purchase fuel (standard unleaded pump gasoline) from any retail public fueling stations or marinas. However, the conducting club reserves the right to specify one or more “outside” fuel suppliers at each race site in an effort to minimize confusion surrounding fuel testing. Competitors may not supplement standard unleaded pump gasoline with any additives that will increase the oxygen content, octane rating or enhance the power output of the engine in any way. “Supplement” is defined as physically adding (pouring) any substance other than standard unleaded gasoline into the boat’s fuel tank or introducing any substance other than standard unleaded pump gasoline into the fuel system.) Standard unleaded pump gasoline without additives is defined as unleaded fuel that meets the standards of petroleum-based fuel as defined by American Society for Testing and Materials (ASTM), designation D4814, with the following clarifications:
- a) Specific gravity must be ≥ 715 and ≤ 765 at 60 degrees F
 - b) Maximum oxygen content is limited to 4.0% by weight.
 - c) The only allowable oxygenates are ether, alcohols or other current EPA allowed oxygenators, as listed and characterized for oxygen mass fraction in ASTM D4814.
 - d) The ethanol content must be less than 25% by volume.
 - e) Oxygen bearing compounds are not allowed.
 - f) Epoxides (i.e. propylene oxide) will not be considered as ether.
 - g) Nitrogen bearing compounds are not allowed.
 - h) Lubrication additives are permitted, provided the resulting mixture meets all other requirements of these rules.
 - i) Unleaded gasoline may not be mixed with any commercial race fuel regardless of the source.
 - j) The following substances (including but not necessarily limited to) are limited in amount by law or not allowed in standard unleaded pump gasoline: Acrylonitrile, Aminodiphenyl, Aniline, Benzene, Benzidine, Beryllium compounds, Bromine compounds, Chloromethyl ether, Chlorine compounds, Ethylene oxide, Hydrazine compounds, Manganese compounds, Nitrobenzene, Nitrochlorobenzene, Nitrogen compounds, Nitrodiphenyl, Propylene oxide and Tert Butyltoluene. If concentrations of any of these substances greater than that allowed by the current EPA upper limits or any substances not listed as a part of commercial gasoline as defined by ASTM D4814 are found in a fuel sample, the competitor will be disqualified from the race and fined \$1,000.00. A second offense will result in a one-year suspension. A third offense will result in a lifetime ban from APBA.
 - k) The use of compressed nitrous oxide as an engine performance enhancing product is prohibited.
 - l) Accepted Methods of Fuel Testing:
 - 1) Digitron Testing
 - 2) Cerium Nitrate Reagent Testing
 - 3) Water Solubility Test
 - 4) Gas Chromatography (performed by an independent outside laboratory)
 - 5) Any other method as recommended by independent outside laboratory or described in ASTM D4814

NOTE: Fuel contents are protestable. However, the loser in the protest shall be responsible for all outside laboratory expenses associated with the protest.

18. ECMs: The chief inspector has the right to impound any ECM unit at any time. The chief Inspector or any competitor may replace a competitor’s ECM at any time with a new fully functional unit.
19. Data Logger: The race committee reserves the right to install a sealed data logger on any competitor’s engine prior to a race. The data logger will be used to assure that the competitor’s engine complies with the engine rules by measuring engine RPM and/or engine spark timing. The conducting club’s inspector will remove the data logger after the race and compare the recorded data to the manufacturer’s specifications. Any engine found out of specification will be disqualified.

20. GPS System: The race committee reserves the right to require a GPS system on each competitor's boat prior to a race.
20. Routine Maintenance: All routine/owner maintenance is limited to: engine oil change, spark plug change, spark plug cable change, replacement of fuel pressure regulator-must be set at factory specifications, engine timing setting, valve lash adjustment and replacement of valve springs and rockers, (valve adjustments must be set to factory specification, using only 1.7 ratio rocker arms). These services must be performed with the procedures and the original parts as outlined in the approved engine service manuals.
21. Approved Outdrives: Outdrives are required to be standard production units. A production unit is defined as one that is available to the general public for recreational use, and is produced in quantities of 25, or more units per year. Any engine or outdrive manufacturer meeting the minimum quantity production criteria may apply to the Technical Committee for approval of their product for competition. Approval is subject to production quantity verification and determination that no competitive advantage will be realized.
- Approved Outdrives:
- MerCruiser Bravo One- Must comply with applicable rules
 - MerCruiser Bravo X, XZ- Must comply with applicable rules
 - MerCruiser Bravo XR- Must comply with applicable rules
 - MerCruiser Bravo XR Sportmaster- Must comply with applicable rules
 - MerCruiser Bravo XR Short Sportmaster- Must comply with applicable rules
 - IMCO SC and SCX- Must comply with applicable rules
22. SKEGS MAY NOT BE SANDED OR THINNED IN ANY WAY. Gear cases may not be blue printed. There shall be a minus 3/16" tolerance on skeg length.
23. Approved Drive Ratios: All **PROSTOCK V** boats shall be restricted to 1.50:1 final drive ratio.
- Gear tooth count
- | | |
|----------|-------|
| XR Upper | 19/16 |
| XR Lower | 15/19 |
| XZ Upper | 32/27 |
| XZ Lower | 15/19 |
24. Transom Assembly: All Bravo Style Outdrives MerCruiser Bravo, Bravo HP, IMCO or MerCruiser ITS.
25. Drive modifications: Allowed only to increase reliability. Examples: One-piece propeller shafts, heavy-duty bearing carriers, etc. Parts must be available to all racers at reasonable commercial prices. Water intake slots on the gearcase CANNOT be closed by any means. The original shape of the gearcase is not to be altered. Other modifications to the outdrive(s) or its components require written APBA approval.
26. Transmissions: Transmissions may not be used.
27. Standoff boxes: Permitted to a maximum of 12 inches. All bottom modifications allowed, and each standoff box must be type approved by APBA.
28. X- dimension: Maximum X-dimension is one half inch below the bottom of the boat when checked with the straight edge from the lowest point of the aft running surface directly in front of the drive and behind the last step of the hull (notches and rockers excluded). For purposes of measurement, the centerline of the propeller shaft must be parallel with the aft running surface.
29. Drive Case Housings: Upper and lower drive case housings need to remain as manufactured. Housings may not be modified. An approved spacer between the upper and lower drive housing can be utilized. Spacer may not exceed 3". Water pickup slots can be made longer or shorter, on IMCO lower to control water pressure. Mercury Sport Master lower unit may close off two outside slots, while maintaining center slot to control water pressure to engine.
30. Power Steering Pumps: Stock power steering pumps can be replaced. Pumps must be located in the original OEM location on the engine.
31. Approved Propellers: Any cast stainless steel propeller with six or less bladed manufactured by Mercury,

Hydromotive, Throttle Up or Hering are legal. MAX PROP PITCH - 31", MAX PROP DIAMETER - 15 5/8". Propellers must be intended for sale to the public at commercially reasonable prices.

32. Steering - External: Hydraulic steering is required. The original power steering pump or after-market pump must be used on all boats.
33. Ballast: All movable ballast must be fixed in place at the beginning of a race. No movable ballast weight may be transferred or relocated while the boat is under way. Ballast water tanks are allowed and may be filled and emptied during the race.
34. Any boat found with an illegal motor part(s) (anything other than what Mercury sold the motor as new or rebuilt) the owner will forfeit any and all points accrued that racing season, up until the time of the infraction. The boat will be disqualified from competition, until such time as the motor has been returned to its stock configuration and sealed by Mercury Marine.

SUPER STOCK CLASS (formerly known as CAT LITE)

All Super Stock Class boats must adhere strictly to the following specifications. Please also refer to the rules pertaining to all APBA Offshore classes.

1 - Dimensions:

Hull type:	Catamaran
Length minimum	28' 0"
Length maximum:	32' 0"
Beam maximum	10' 6"
Tunnel width maximum (measured at keel)	63"
Weight minimum 28 feet:	3,800 lb.
Weight minimum 29 feet:	3,925 lb.
Weight minimum 30 feet:	4,050 lb.
Weight minimum 31 feet:	4,175 lb.
Weight minimum 32 feet:	4,300 lb.

Any boat with less than a 63" tunnel may reduce its overall weight by 25 lbs. per inch of tunnel width.

2 - Engine specs: (Twin engines)

- **Approved Engine:** Mercury 300xs, 2006-current, 300 hp, 3.2L (193 CID) with Sportmaster lower unit.
- **Cowlings:** May be a light weight facsimile of the production cowling. Manufacturers decals must be on cowling.
- **Powerhead:** Must remain stock as produced by the manufacturer. The year must be declared prior to the race.
- **Balancing and Blueprinting** is not allowed. Balancing and Blueprinting shall be defined as (but not limited to) "cleaning -up", "bringing to spec", removing or adding any metal or any other material to balance any reciprocating parts. Media blasting and bead blasting not allowed.
- **Compression ratio:** May not be altered
- **ECU boxes:** May not be modified or reprogrammed. Maximum RPM allowed 6400.
- **Flywheels:** No modifications or lightening is allowed.
- **Reeds:** Any reeds are allowed. Stock reed cages must be used.
- **Lower unit:** Must remain stock as produced by the manufacturer. Any OEM gear ratio is allowed. Blueprinting and Trueing are not allowed. Media blasting and bead blasting not allowed.

3 - Engine Specifics:

The center section/mid-section may be converted to the Mad EFI 15" offshore (3L top to 3L bottom). The exhaust system must remain stock as produced by the manufacturer however the "Muffler" must be cut off to fit inside 15" center section.

- **Updating of equipment:** Allowed
- **Backdating of equipment:** Not Allowed
- **After Market Tuner:** Allowed

4. Propellers:

- 5. Steering - External - Hydraulic steering is required.**
- 6. Remote Water Pickups:** Not Allowed
- 7. Fuel:** Only petroleum-based fuels are allowed. Octane enhancing additives are not allowed. Oxygen

enhancing additives are not allowed.

- 8. Tunnel tabs** - May extend into the tunnel 40 inches maximum and extend aft from the transom 36 inches maximum. Air dams or fences are allowed. The maximum width of the tunnel tab shall not exceed the width of the tunnel measured at the keel.
- 9. Safety** - All Cat Outboard boats are required to have ½ inch or thicker canopy glass and compression strut or adequate reinforcement for structure safety.
- 10. Adjustable Motor Brackets:** Jack plates must be manually adjusted and may not be movable while the boat is under power racing.

UNLIMITED (Formerly EXTREME LIMITED CLASS)

All **Unlimited** Class boats must strictly adhere to the following specifications.

Hull Specifications:

Hull type:	Any *
No. of Engines	Maximum Two (2)
Length minimum	40' 0"
Length maximum:	46' 0"
Beam maximum	12' - 4"
Tunnel width	76"
Height minimum:	48"
Weight minimum:	10,500 LBS.

* - No 3- or 4-point hydroplanes allowed

1. Engine Specifications:

- a) Allowed Engines: Any Piston Driven Engine derived from a "GM" or Mercury Marine Chevrolet type block. Any modifications are allowed to enhance operation in a Maximum RPM marine racing environment.
- b) Engines shall be limited to 6800 RPM Max

2. Transmissions: Single Speed; Multi Speed Transmissions not allowed.

3. Drives: Any

4. Propellers: Cast stainless steel or forged propellers only. No billet, titanium or other type propellers allowed.

Note: Minimum blade thickness shall be based on Mercury 1350 propeller specifications.

5. Rudder Specifications:

Materials	Stainless steel or titanium only
Serial number	Unique stamped or engraved, required
Minimum thickness	0.350", any fore-aft chord
Edges, sharpening	Allowed
Rudder shape	No Restrictions
Dimensions	No Restrictions
Depth	Rudder must extend at least 5" below keel @ max lift
Trimmable	Not Allowed
Liftable	Not Allowed

6. Fire Suppression: A minimum of one Coast Guard certified fire extinguisher per engine compartment. Extinguisher must be sized according to Coast Guard regulations.

7. Fuel: Only 87-93 Octane (R+M/2) petroleum-based fuels are allowed. Octane and/or Oxygen enhancing additives are not allowed.

VEE EXTREME (Formerly SUPER VEE CLASS)

All VEE **EXTREME** Class boats must adhere strictly to the following specifications. Please also refer to the General Technical rules pertaining to all APBA classes. (VEE EXTREME class may also be referenced as VX.)

If this rulebook does not specifically say that you can do or use something, then you must consider that the action, change or component is illegal. No equipment or race boat in violation of these rules will be considered as having been approved by reason of having passed through pre-race inspection or post-race inspection at a prior event, “unobserved”.

Any questions about the legality of any change, or of any action, part, or component, must be submitted in writing and answered in writing by the ORC prior to the change or use. The ORC is empowered to make any technical rule changes it deems necessary to maintain competitive balance and/or safety for the boats competing in the VEE EXTREME class.

All boats as well as every part used in connection therewith, including but not limited to engines, outdrives, transmissions, crash boxes, and propellers (and all parts and components related thereto) must be both manufactured and intended for sale to the public at commercially reasonable prices. Exclusivity agreements of any type that have not been approved by the ORC are strictly prohibited. This rule applies to competitors only and shall not be construed in any manner whatsoever to limit or restrict the conducting club from entering into exclusivity agreements such as official sponsorships involving single source vendors, suppliers, manufacturers or producers.

If there is a disagreement or dispute about the APBA Technical Rules, the interpretation of the ORC shall prevail. Decisions must be rendered in writing.

Hull Dimensions:

Hull Type:	Twin Engine Monohull
Length Minimum	35' 0”
Length Maximum:	46' 0”
Beam Maximum	9' 3”
Height Minimum: (Keel to Deck)	All boats for VEE EXTREME class must measure at least 48” from the keel to the deck forward of the canopy (not including the canopy).
Weight Minimum:	9,000 LBS

Minimum Weight Measurement - is determined at the end of the race. All boats required or directed to weigh by the Chief Referee or Inspector must report to the Crane of the Day, the same crane must be used for both entering and exiting the water. It will be the responsibility of the Owner, Driver, or designated Crew Member to present the boat for Post-Race weighing with the boat in the lifting harness in a level position, with the hull drain plugs removed and the boat empty of water, with all ballast tanks empty, and all helmets and jackets removed. If the Inspector or Chief Referee finds otherwise the boat will be immediately assessed a two (2) minute penalty. No private cranes or scales will be utilized for Official weighing compliance purposes. The weight will be an all-up weight including engines, residual fuel, drives, propellers, fixed ballast (i.e. that which is used from start through completion of race). No multiple weighing, one only (one in and one out).

Canopies – Vee Extreme registered race boats are required to have canopies.

1. All Canopied boats are recommended to comply with the latest canopy design and technology. Contact the boat manufacturer for their canopy standards.
2. Any damage to canopies must have a notarized certified letter from a manufacturer of canopies authorizing the continued use in a race.
3. Non-compliance – The conducting club has the authority to deny entry to any race boat subject to these rules that has non-compliant cockpit safety systems.

1. Engine Specs:

Displacement, Maximum	572 CID (per engine)
Compression Ratio	Maximum 9.5:1, no minimum - Measured by Whistler device calibrated at race site with master cylinder.

2. Valve System:

Number of Valves	Two valves per cylinder operated by pushrods.
Variable Cam Timing	Not allowed
Maximum Gross Cam Lift	0.740-inch, zero lash, measured at the valve

3. Engine Blocks:

Cast Iron - Painting Block Is Allowed	General Motors, World Products (Merlin), and Dart blocks in their stock OEM configuration and must be approved by APBA.
GM - Chevrolet Design	Any Block with 9.8" or 10.2" deck heights approved
Sleeves or bushings	May be used providing the original OEM (GM) lifter bore location is not changed
Pushrods	Must ride in the center of the lifter. (no offset lifters)

4. Internal Components:

Materials Allowed	Crankshaft, connecting rods, pushrods and wrist pins must be made of steel.
Materials, Not Allowed	Titanium or any other materials
Single Plane Crankshafts	Not allowed. Crankshaft throws must be timed according to OEM specifications.

5. Cylinder Heads:

Cylinder Heads	Only the approved aluminum cylinder head is allowed.
Approved Head	Dart Pro-1, CNC Ported Aluminum Cylinder Head - Part Number #19574030. Cylinder head serial numbers must remain on the head and may not be defaced or altered.
Cylinder Head Modifications / Repairs	All repairs must be performed by Dart - No modifications to the original head castings are allowed.

6. Intake Manifold:

Approved Intake Manifolds	Any Stock Cast Intake Manifold.
Modifications	The manifold may be port matched up to 1 ½ "to match cylinder heads
Not Allowed	Fabricated or Tunnel Ram type manifolds
Carburetor Spacers Allowed	Maximum 2.5" between the bottom of the carburetor and the top of the manifold

7. Induction System:

Type	Naturally Aspirated Engines Only. No forced induction allowed.
Approved Type	Any Holley Dominator style carburetor is allowed

	Only 1 Carburetor is allowed per engine
Fuel Injection	Not allowed
Source	Carburetors may be purchased from any source
Fuel	91 – 93 Octane, no fuel additives or Oxygenated Fuel is allowed

8. Exhaust System:

Materials	Any
Shape	Any
Modifications	Any
Cooling	Exhaust system from engine outlet to point of exit from hull or deck must be water - cooled by water jackets.
Proper Ventilation	The exit from the hull must be located in such a position that exhaust fumes cannot affect the crew.

9. Transmissions:

General – All boats competing in the VEE EXTREME class must have propulsion systems capable of turning the propellers in either direction or maintaining a neutral (standstill) state while the engine is running.

Single Speed - Transmission / Crashbox capable of forward, neutral, and reverse are allowed.

Multi Speed – Transmissions Not allowed

10. Lubrication:

Wet Sump	Wet sump and internal oil pumps allowed
Dry Sump	External oil pumps or dry sumps allowed, however a maximum of three scavenging pump sections allowed.
Intake Valley	Must remain as cast with NO alterations to prevent oil flow from the valley to the crankcase. No raised sections may be attached or formed with any material around oil drain openings in the intake valley. No “damming” or collecting of oil by any means is allowed in the intake valley.

11. Ignition:

Distributor	Must remain in factory delivered location
Spark Distribution	Distributor rotor / cap only
Electronic Ignition	All VEE EXTREME class Engines are required to use the MSD Digital or Analog Ignition System limited to 6600 RPM's. A G2X Data Logger must be installed and maintained to monitor the RPM level during the race. The RPM level during the entire race must be verifiable on the Data Logger by the Inspector, upon completion of the race, during the Post-Race Inspection. The Ignitions with an internal dial up RPM limiter will be set and sealed by the Inspector. The wiring harness of the system must be accessible and provide the ability for an Inspector to examine it. No Dual Systems or Ignition Components are allowed. Any boat competing in the VEE EXTREME class that exceeds the above listed MAXIMUM RPM LIMIT, as determined by the Inspector will be awarded last place points and will not be eligible for trophies, flags, or prize money.
Crank Triggered Ignition	Not allowed
Belt Drive Ignition	Not allowed
Coils	Ignition systems are limited to one (1) ignition coil. Individual ignition coils per cylinder are not allowed.

Back-up Ignition System	Not Allowed.
Rev Limiter	RPM limited to 6600 RPM. A G2X Data Logger must be installed and maintained to monitor the RPM level during the race. The RPM level during the entire race must be verifiable on the Data Logger by the event inspectors during post- race inspection. The wiring harness of the system must be readily accessible for inspection by event inspectors. No dual systems or ignition components allowed. The RPM level during the entire race must be variable on the data logger by the APBA inspector upon completion of the race.

12. Drives:

Approved Type	All Mercury, Arneson and Arneson type drive systems are allowed. Drive systems must retain their original OEM configuration and specifications. No internal or external modifications are allowed. Any other type of drive system must be approved in writing by the OTC.
Surface Drives	Allowed
Gear Ratio	1.57:1 (Mercury #6) or 1.56:1 (Arneson) gear ratio at propeller

13. Engine Suppliers:

Multiple engine builders to supply engines that meet the VEE EXTREME class engine specifications are allowed.

The Goals of the VEE EXTREME class – spec engine program is to:

- Increase competitive balance throughout the fleet
- Develop an “8 race engine”
- Reduce the maintenance and operating costs for the majority of the teams during an entire season.
- Increase reliability and durability
- Increase performance and acceleration so the VEE EXTREME class boats can negotiate the tighter multi turn courses more effectively.
- Increase the number of teams that can afford to field competitive VEE EXTREME class entries.
- “Recession” proof its racing product by decreasing reliance on outside third-party suppliers for the propulsion systems used in the race boats.

14. Propellers:

- a) Only propellers manufactured by Mercury Marine, Hering, and Rolla are approved. Other manufacturers of cast propellers may apply to APBA.
- b) Propellers must be manufactured from cast stainless steel castings. No forged, billet, titanium or other propeller types.
- c) All propellers are limited to a minimum thickness required for prop integrity. Propeller blade thickness shall conform to the criteria provided in the charts and diagrams in these rules.
- d) All propellers must pass inspection standards for blade thickness.
- e) Propellers must be intended for sale to the public at commercially reasonable prices.

15. Ballast Tanks - Allowed. No transferable closed liquid ballast systems allowed.

16. Air Scoops – Engine hatches with or without scoops are allowed. It is illegal to completely seal the inlet air track running from external openings to the flame arrestor. Fresh air ducting must be no closer than 2” at its nearest points to the engine and/or flame arrestor. Sealing or pressurizing the engine compartment is not allowed.

17. Illegal Parts – Use of illegal or unauthorized parts on a VEE EXTREME class race boat will result in the

confiscation of the said parts. Failure to surrender the illegal part(s) will lead to mandatory suspension for the boat, the boat owner, and all riding crew members until the illegal part(s) are surrendered. It shall be the responsibility of the owner or his designated representative to take whatever actions are necessary to ensure the correct components are present.

Propeller Inspection Specifications for VEE EXTREME SSM VI Drive Type

Propeller Diameter		Strike Radius at:		
15"	Inch	2"	4 1/4"	6 1/2"
15 1/4"	Inch	2"	4 5/16"	6 5/8"
15 1/2"	Inch	2"	4 3/8"	6 3/4"
15 3/4"	Inch	2"	4 7/16"	6 7/8"
16"	Inch	2"	4 1/2"	7"
16 1/4"	Inch	2"	4 9/16"	7 1/8"
16 1/2"	Inch	2"	4 5/8"	7 1/4"
16 3/4"	Inch	2"	4 11/16"	7 3/8"
17"	Inch	2"	4 3/4"	7 1/2"
17 1/4"	Inch	2"	4 13/16"	7 5/8"
17 1/2"	Inch	2"	4 7/8"	7 3/4"
17 3/4"	Inch	2"	4 15/16"	7 7/8"
18"	Inch	2"	5"	8"

Intersect Radius Line at:

Radius	Distance from Leading Edge	Thickness
2"	1 3/8"	.283"
4 1/4" to 5"	1 1/2"	.182"
6 1/2" to 8"	1 11/16"	.115"

Intersect Radius Line at:

Radius	Distance from Leading Edge	Thickness
2"	1 1/2"	.475"
4 1/4" to 5"	1 1/2"	.302"
6 1/2" to 8"	1"	.130"

SUPER VEE XTREME (SVX) – Technical Rules

The Super Vee Xtreme class is designed for racers that want the safety of being in an enclosed canopy while enjoying deck to deck competition against similar boats with identical power. The rules that follow are safety- and competition-based. The formula endeavors to keep competition close and exciting, principally by restricting technology changes and limiting the differences between racing equipment from team to team in order to ensure maximum excitement and enjoyment for racers and fans alike. The Super Vee Xtreme class will also be known and referred as SVX.

The class known as SVX will divide equally whatever money has been slotted to the class. Any boat that is at the race site, registered, and attempts to race, qualifies for the purse. First, second, and third place boats will receive the trophies if awards are given out. You will need to contact Registration at least 3 weeks prior to the race and notify the conducting club of your attendance.

If anything is not listed in these technical class rules, you should assume the answer is NO. Officials may interpret these rules based on circumstances at the time.

Rule Changes to Maintain Competitive Balance: The ORC recognizes that there are considerable differences in boat design; accordingly, the ORC reserves the right to make adjustments to boats, engines, drives, or propellers, etc., individually or categorically, based upon experience in race conditions.

Hull Specifications

All Super Vee Xtreme (SVX) teams must adhere to the following specifications along with the general rules pertaining to all APBA Offshore classes.

- Any new team racing with an APBA club for the first time must notify the conducting club at least 60 days prior to the race they plan to attend. The boat will have to pass the conducting club's inspection and sea trials prior to qualification to race. All bottom modifications are allowed, but parity will be throughout the season for all teams.
- Extensions to the deck of the boat both fore and aft are allowed. Any additions will be included in the overall measurement of the hull.
- Hull extensions may not be used to meet minimum length.

Weights and Dimensions

Hull type: Monohull

Length minimum 26'

0"

Length maximum – Bow to Transom – 32' 0"

Beam maximum: 8' 6" (The maximum beam shall be no more than 2' wider than the beam measured at the transom chine to chine)

Number of engines: 1

Hull steps - are allowed and must be vented to the atmosphere either internally or externally.

Weight Minimums

1. Single Step Hulls: Bravo, Imco drive- 4750 lbs.
2. Twin Step Hulls: Bravo, Imco drive- 5000 lbs. at first race – adjusted for parity by the conducting club.
3. Triple Step Hulls: Bravo, Imco drive- 5250 lbs. at first race – adjusted for parity by the conducting club.

Penalties

1. Under Weight: This will result in a last place finish for the day.
2. Multiple Offenders: Place will be determined by amount of weight under. No scale tolerance.

Minimum Weight Measurement will be determined at the end of the race. The weight will be an all-up weight including engines, residual fuel, drives, propellers, fixed ballast (i.e. that which is used from start through completion of race), all hull drain plugs removed, and safety equipment as stated in the racing rules. The following is not included in the all-up weight: crew, lifejackets, crash helmets, bilge water and lifting harness.

A single point lifting harness is mandatory for all boats. It shall be the responsibility of the crew to ensure that the single point lifting system harness positions the race boat so as to drain all onboard ballast tanks per the rule.

Canopies: All boats must be equipped with canopy safety systems, including canopy hatches (lids) fitted with positive open and positive close mechanisms, side by side only. No inline seating allowed. Five-point restraint harness systems and on-board air systems are required. No boat will be permitted to participate without a canopy. The conducting club has the authority to deny entry to any race boat subject to these rules that has non-compliant cockpit safety systems.

Braking Systems: Not allowed

Aero-dynamic Devices (such as wings or moveable deck surfaces) – not allowed.

Anti-Stuff Bow Planes - not allowed.

Non-Skid- All boats must be equipped with non-skid material on the deck from the transom up to and around the canopy.

Engine Compartment- Only engine compartments with ridged covers/hatches and a highly visible color underneath may be used.

Exclusivity agreements for boats or any component used in racing are not allowed.

Handrails (max. height of 6"), or hand holes, extending fore and aft, must be fitted to deck of hull. Cables and lifelines are not approved.

ENGINE SPECIFICATIONS

APBA Approved Inboard Production Race Engine

- Mercury Racing 525 EFI Motor, with its OEM Stock Specifications, with the following exceptions a maximum cubic inch limitation of 510 Cubic Inches and a maximum RPM limitation of 5400RPMS.
- The SVX Class 510 CID Motor with the following specifications:
 - ❖ **Displacement:** Maximum 510 CID, with a 4" stroke crankshaft only. Crankshaft throws must be in accordance with OEM specifications
 - ❖ **Compression Ratio:** Maximum compression ratio of 9.0:1.
 - ❖ **CAM:** Any hydraulic roller cam with a maximum intake lift of .610 inch and exhaust lift of .632 inch measured at the valve with zero lash is the only cam allowed, with an OEM stock gear timing chain, no belt driven timing chain systems are allowed. Variable cam timing not allowed.
 - ❖ **Block:** Chevrolet designed blocks, with their OEM specifications, NO MODIFICATIONS, manufactured by General Motors, World Products and Dart must be approved by the conducting club.
 - ❖ **Materials:** Crankshaft, Flywheel, connecting rods, pushrods, and wrist pins must be made of steel. Titanium or other materials are not allowed.
 - ❖ **Heads:** The approved cylinder head is the Dart Pro I Head, Part Number 19100010M (bare head) or 19100112M (complete head with valves and springs) with their stock OEM specifications, no modifications allowed. 1.7 ratio rocker arms on stud mounted rocker arm shafts only. The head serial numbers must remain on the head and may not be defaced or altered. The Stock Mercury 525 OEM Head with its OEM specifications and no modifications may be used.
 - ❖ **Intake Manifold:** Any stock cast intake manifold with a Holly Carburetor 4150 style (size) base may be used. No fabricated or tunnel ram type manifolds may be used. Intakes may be port matched

- up to 1 ½ inches to match cylinder heads. Carburetor spacers or adapters are NOT ALLOWED.
- ❖ **Induction System:** One Holley carburetor 4150 style (size) only is allowed. Naturally aspirated only, no forced induction allowed.
- ❖ **Lubrication (Engine):** External oil pumps or dry sump systems are not allowed.
- ❖ **Ignition System:** Engines are required to use the MSD Digital or Analog Ignition system limited to 5400 RPMs. Crank triggers and belt drive ignitions are not allowed.

Ignition System: All engines are required to have the ignition system limited to 5400 RPMS and have a G2 Pro Data Logger installed and maintained to monitor the RPM level during the race. The RPM level during the entire race must be verifiable on the Data Logger by the inspector upon the completion of the race, during the Post-Race inspection. No dual systems or ignition components are allowed.

Maximum RPM Limit: Any boat competing in SVX that exceeds the above listed MAXIMUM RPM LIMIT, as determined by the event's Inspector "WILL BE" awarded last place points and will not be eligible for trophies, flags, or prize money.

Engine maintenance and rebuilds: The respective motors can be maintained and rebuilt, utilizing stock OEM parts and specifications, with a maximum cubic inch limitation of 510 cu in and a maximum compression ratio of 9.0:1, all other engine specifications and tolerances must be as per the Original Engine Manufacturer or have approval from the conducting club in writing. Note: Aftermarket 502 cubic inch GM blocks may be used.

Penalties: Any violations of the above rules may result in the immediate disqualification of the subject competitor and a fine.

EXHAUST SYSTEM SPECIFICATIONS

- **Exhaust Manifolds and Headers** - Must remain as originally produced by the manufacturer and may not be modified in any way without the written approval of the conducting club.
- **HP 525 EFI Engines & the SVX 510 CID Motor** - Only CMI Gen X Style Header, the HP 525 EFI Style Header, the CMI Straight Back Sweeper Header, or the Innovation Marine Tractor Style Header is permitted.
- **Tail Pipes and Exhaust Tips** - Any tail pipe or exhaust tip is allowed. Tail pipes may be of any length and can exit the boat through the gunnel, deck or transom. The engine exhaust headers and pipes from the engine outlet to point of exit from the hull or deck must be water-cooled by water jackets. The exhaust outlet/tip may not exceed more than 12 inches beyond the transom of the boat. Dry tail pipes are allowed but must be water jacketed.
- **Cooling Water** - Neither the method, nor the volume of cooling water flow to the exhaust system may be altered from the production configuration. All engine cooling water must pass through the exhaust elbow/tail pipe and either into the exhaust, an onboard ballast tank fill or to a thru hull fitting. No water can be diverted for exit elsewhere.
- **Non-Conforming** – The conducting club reserves the right to approve alternative additional exhaust installation hardware when required for specific boat builder installations.
- **Rear Engine Mounts** - are allowed

OUTDRIVE SPECIFICATIONS:

- **Approved Models** – The Mercruiser Bravo One, XZ, XR, Sportmaster, Short Sportmaster XR, BMAX, and Imco SC and SCX Drives are approved for competition.
- **The Volvo DPX Duo Prop** is approved for competition.
- **Nose Cones** - Approved Nose cones are allowed. Check with the conducting club prior to using a particular nosecone to ensure it is approved for competition.
- **Crash Boxes** - are not allowed.
- **Gear Ratios** - the only gear ratio allowed is 1.50.1 at the prop shaft.
- **Dry sumping** - of drives is not allowed.
- **Shifting** - Drives must be capable of shifting forward, neutral and reverse with the engines running.
- **Modifications** - Drive modifications (i.e. one-piece propeller shafts, heavy-duty bearing carriers, etc.)

only to increase reliability are allowed. Parts must be available to all racers at reasonable commercial prices. Any other modifications to the outdrive (s) or any related components must first be approved by the conducting club in writing prior to being used in competition.

- **Transmissions** - are not permitted in SVX.
- **Standoff boxes** - Must be of a design, size and length that have been approved in writing by the conducting club. Check with the conducting club prior to using a particular standoff box to ensure it is approved for competition. Standoff boxes are limited to a maximum of 12”.
- **Jackshafts** - are allowed.
- **X-Dimension – Weight Modification** - In an effort to create parity between boats, the maximum drive height for SVX boats shall be limited to the centerline of the prop shaft being a minimum of one half inch (1/2”) below the bottom of the boat, as measured with a straight edge (laser) off the aft running surface, directly in front of the drive, with the prop shaft trimmed parallel with the aft running surface. Notches, strakes and steps will be excluded. In addition to the X-Dimension, the Minimum Weight Requirement may also be modified to create parity.

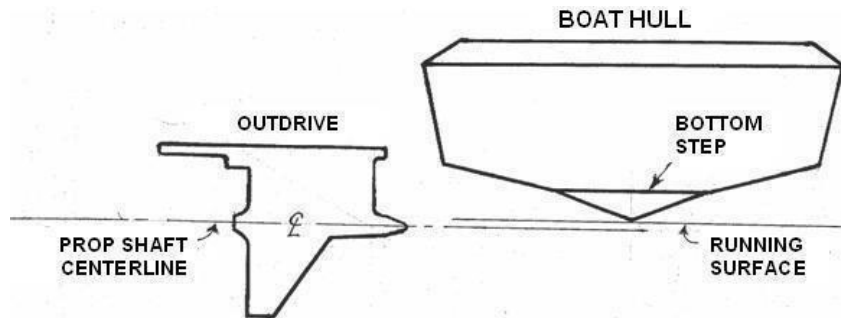

- **Parity** – In an effort to create parity within the SVX Class, after two consecutive wins, the conducting club will implement one or any of the following. It will be at the conducting club’s discretion to what degree and which of the following will be implemented.
 - **X-Dimension:** Adjust the X-Dimension on an individual basis. (see diagram)
 - **Weight Modification:** Control the weight of any individual boat, in an effort to maintain the competitive balance of the class. (see diagram)
 - In addition to the minimum weight adjustment, the conducting club reserves the right at their discretion to also modify the drive height of any boat at any time either in conjunction with the weight adjustment or separately in an effort to maintain a competitive balance in the class.
- **Casings** - The upper and lower drive case housing must remain in its original production configuration. The drive case housing may not be shortened or modified. Blue printing is allowed; however, the casings must meet the specifications of the club approved manufacturer’s template.
- **Propeller Rotation** - Inboard or Outboard Rotation of propellers is allowed.
- **Water Pickups** - No thru-hull water pickups will be allowed. Engine cooling water must be supplied through the stock outdrive water pickup.

PROPELLER SPECIFICATIONS:

- **Castings** - Propellers must be manufactured from castings.
- **Modifications** - Propellers may be modified from the original factory casting with grinding and machining.
- **Forged, billet** - or other types of propellers are not allowed.
- **Availability** - Propellers must be available to all racers within a reasonable delivery time.
- **Approved Propellers** – Cast propellers must be approved by the conducting club.
 1. Three, four, and five blade cast propellers manufactured by Hering, Hydromotive, Throttle-Up, and Mercury are approved.
 2. Six blade cast propellers manufactured by Hering, Throttle-Up, and Hydromotive are approved.

3. Other manufacturers of cast propellers may apply to the conducting club for approval based on the following criteria:
 - a. Reasonable prices and available to all racers.
 - b. Manufacturer maintains national availability through a national dealer network.
 - c. Units are available to, and generally recognized by, approved boat manufacturers as OEM Equipment.

EXTREME CLASS RULES

Turbine Powered Boats Engines

allowed: Lycoming T53 series engines
Lycoming T55 series engines
Pratt Whitney PT series engines
GE T58 series engines

1. Lycoming T55 series restrictions: #1 3.5 GPM maximum fuel consumption, #2 92% Max N1 speed, #3 100% maximum N2 speed. Turbines CAN be modified from their original manufactured configuration to better suited the Marine environment, and racing conditions.
2. Entire exhaust systems must be Water cooled or insulated. No Flames show or after burners allowed.
3. An engine output shaft rev limiter shut down (Electric or mechanical set @ 115% N2 speed) switch must be in place on each engine. An electrically operated engine kill switch must be in place on each engine. An electric or manual emergency fuel shut off, or bypass, must be in place on each engine.
4. A minimum of one Coast Guard certified fire extinguisher per engine compartment. Extinguisher must be sized according to Coast Guard regulations. Extinguisher electric activation solenoid MUST be connected to engine kill switch.
5. Only Jet A, Kerosene, and/or diesel is permitted as fuel. (Gasoline is not permitted)
6. A Kevlar containment blanket must be used on hot end of every engine to contain any GP or PT rotor failure. (35 layers of Kevlar minimum)
7. Only 2 engines may be installed, providing safety requirements per engine are met. Any drive or propulsion configuration utilizing the thrust of water, and/or any drive ratio can be used.
8. Boat speed is limited to 150 MPH at any given time for all boats, no exceptions.
9. Only canopied boats are permitted to race in class

Piston Powered Boats

1. Only 2 engines may be installed
2. Unlimited power is accepted with piston power providing safety requirements per engine are met
3. Any drive or propulsion configuration utilizing the thrust of water, and/or any drive ratio can be used
4. Boat speed is limited to 150 MPH at any given time for all boats, no exceptions
5. Only canopied boats are permitted to race in class

APBA BRACKETED CLASS RULES

1. The racers must stay in their bracket speed at any time the race course is deemed “hot”. If a race boat exceeds the speed in any lap by less than one mile per hour, that team will receive last place points. If a race boat exceeds the top speed of its class by more than one mile per hour, the boat will be disqualified, will receive no points and must move up a class for the remainder of the season. The race boat that moves to the next class will not take any accumulated points with the boat to that class nor will they need to pay another equipment registration fee.
2. The speeds are based on the distance of the actual racecourse. Before the race starts, a race official will give scoring a GPS reading of the distance. This is put into the computer along with your time to compute lap speeds.
3. Boats shall be a minimum length 20’, maximum length 55’ (see exceptions below in specified classes).
4. Class race boats will be identified with only the class numbers as their assigned number.
5. The Class that you will be racing in will be on your estimated speed of your boat. If you do not know what class you should be in, speak to the Referee or the Chief Inspector.
6. Speeds will be confirmed by GPS.
 - a. Official APBA GPS units are:
 - Racelogic VBOX Sport
 - Racelogic Video VBOX Lite
 - Racelogic HD2 System
 - Racelogic HD2-HDMI
 - b. VBOX units MUST be purchased through OPA. If a VBOX unit is purchased directly from Racelogic or another retailer, the unit will not work with the OPA’s proprietary software. If unable to read your data, you will be disqualified and receive no points for the event.
 - c. Racers MUST hand in the SD Card in which the data was recorded by the VBOX. If a card is NOT submitted for reading within a timely manner, they will be disqualified and receive no points for the event.
 - d. You are not permitted to run your VBOX unit in multiple races.
 - e. VBOX units are the ONLY GPS units that are available to purchase new.
 - f. VBOX units cannot be rented
 - g. VBOX units require an SD Card to have the data recorded on. Below is the required SD file size:
 - VBOX Sport: 4GB minimum, recommended 8GB
 - Video VBOX: 16GB minimum, recommended 32GB
 - Video VBOX Waterproof: 16GB minimum, recommended 32GB
 - h. You will also need to keep your Video VBOX Sport in a waterproof case.
 - i. It is the racer’s responsibility to make sure that the GPS unit is working properly at alltimes.
 - j. It is the racer’s responsibility to make sure that there is ample room on the SD card to record the data from the GPS.
 - k. GPS units will not be allowed to be moved from boat to boat.
 - l. It is the racer’s responsibility have the unit serialized with the race committee’s GPSOfficial.
 - m. To make a purchase of a NEW GPS, you may contact Frank Vecce. Use any of the contact numbers located on the “Contact” page of the OPA website to obtain the phone number for Frank.

How a GPS Breakout is Determined

1. A GPS breakout is any speed that goes above the bracketed class speed for a duration of time that

- exceeds 3 seconds.
2. A GPS breakout speed with a duration time that measures 3 seconds or less will not be counted as a breakout.
 3. For each boat when a breakout occurs, the total duration of time will be the measurement of the total breakout.
 4. Sample breakdown of 2 teams with breakout time durations. Boat A with a total of 13.8 seconds will be scored better than that of Boat B with a duration of 16.3 seconds.
 - a. Boat A (Breakout time duration over 3 seconds)
 - i. 6.7 seconds
 - ii. 3.8 seconds
 - iii. 3.3 seconds

Total time of breakout 13.8 seconds
 - b. Boat B (Breakout time duration over 3 seconds)
 - i. 10.1 seconds
 - ii. 6.2 seconds

Total time of breakout 16.3 seconds
 5. If there is a tie in which more than one team has the same duration of time for breakouts
 - a. The boat that held a breakout for the longest total distance in the race will place latter in the scoring.
 - b. In the event a tie still remains, the boat with the single highest speed will place latter in the scoring.

Bracketed Classes

7. Class 1:
 - a. Boats are limited 115 MPH as a top speed.
 - b. No open cockpit boats are allowed to race in Class 1
8. Class 2:
 - a. Boats are limited 105 MPH as a top speed.
9. Class 3:
 - a. Boats are limited 95 MPH as a top speed.
10. Class 4:
 - a. Boats are limited 85 MPH as a top speed.
 - b. Limited to boats 40 ft and under
11. Class 5:
 - a. Boats are limited 75 MPH as a top speed.
 - b. Limited to boats 30 ft and under with single engine.
 - c. Grandfathered Boat(s)
 - 30' Superboat w/twin O/B known as:
 - "Specialized Racing" Hull # _____ is approved for competition
 - "Dock Blood" Hull # _____ is approved for competition
 - 29' Mirage w/twin I/O known as:
 - "Whoz Your Daddy" Hull # _____ is approved for competition **pending HP approval from the Inspector
 - 29' Panther Scarab w/twin I/O known as:
 - "Panther" Hull # _____ is approved for competition **pending HP approval from the Inspector
12. Class 6:
 - a. Boats are limited 70 MPH as a top speed.

- b. No boats over 26 ft in length
 - c. Bravo based outdrive
 - d. Single engine only
13. Class 7:
- a. Boats are limited 60 MPH as a top speed.
 - b. APBA reserves the right to inspect all boats competing in the class in order to determine that it is in a condition worthy of the event
 - c. All registered hulls shall only be “Vee” hull from 20-22 ft in length
 - d. Hull shall be equipped with a single outboard motor of horsepower not to exceed 300HP
 - e. Boats must have hydraulic steering or dual cable setup
 - f. Class 700 will not participate in any race committee purse monies
 - g. Class 700 will participate in an abbreviated course of 20-24 miles

Class	Top Speed	Class	Top Speed
Class 1	Up to 115 mph	Class 5	Up to 75 mph
Class 2	Up to 105 mph	Class 6	Up to 70 mph
Class 3	Up to 95 mph	Class 7	Up to 60 mph
Class 4	Up to 85 mph		

POWERBOAT P1 CHAMPIONSHIP SERIES RULES



To the extent that any conflict may exist between the general racing rules outlined above and the rules outlined in for the Powerboat P1 Series, the rules for the Powerboat P1 Series shall govern.

Powerboat P1 Management, Ltd. owns the rights to the rules for the Powerboat P1 SuperStock Championship series, and reserves all rights, including but not limited to amendments or modifications to the rules set forth for the Powerboat P1 SuperStock Championship series. The rules outlined for SuperSport, SVS and Evolution within this rule book are intended for application within the APBA, and racing within the sanctioning authority of the APBA only.

DEFINITIONS

D.1 Pilot

The driver, throttle person and, if carried, the navigator, collectively the **Crew**, who operate the Boat during a Grand Prix event, Power Pole, test or practice session.

D.2 Hull

- a. For P1 SuperStock class Boats, this class is a one design series with the only approved boat being the **P1-28R Panther** with the approved outboard engine as specified by the promoter. No modifications from the original factory specifications are allowed.

D5 Terminology Clarifications - Certain terminology may be used within the P1 Class rules that are consistent with the global nature of the categories.

- a. **Promoter / Organizer** - The Promoter or Organizer is defined as Powerboat P1 Management, Ltd. and its subsidiaries.
- b. **Officer of the Day (OOD)** - The term OOD is to be considered interchangeable with Referee as outlined in the APBA General Rules.
- c. **Scrutineer** - The term Scrutineer is to be considered interchangeable with Inspector as outlined in the APBA General Rules
- d. **Grand Prix** - The term Grand Prix is defined as an official P1 Series event sanctioned in accordance with the APBA and UIM requirements.
- e. **P1 TCC** - The P1 Technical Compliance Committee (TCC) is the technical committee for the P1 Series, consisting of individuals from various positions within the industry and sport, and the APBA Offshore Racing Committee.

S1 U.I.M. National Authority License – **If the race is registered as a: International Ordinary, Continental or World Championship then the** Pilots must possess a valid international license issued by their National Authority U.I.M. member; if no national body is a member of the U.I.M., then that pilot must be licensed by another U.I.M. national authority member.

S2 Points eligibility - Unless a race is curtailed, to be eligible for Race Points a Boat must have completed the minimum number of laps announced at the pre-race briefing or issued in a Race Bulletin. If not stated at this briefing or issued in a Race Bulletin the minimum number of laps required to be completed shall be 70% of the total race distance rounded up to the nearest lap. Boats must take the checkered flag to be eligible for Race Points

S3 Curtailment of a Race - A curtailment may be implemented at any time during a race. The race may be curtailed or stopped at the finish line by waving the checkered finishing flag and curtailment flags. Once the curtailment signal has been displayed all Boats will stop racing at the end of their current lap. To be

eligible for points when a race is curtailed, a Boat must have covered a minimum of 70% of the number of laps completed by the first Boat to finish.

Retiring from a race will not preclude a driver from getting finishing points that would otherwise be awarded if the race is curtailed after a Boat retires.

S4 Race Points - Race Points shall be awarded for each race. For the allocation of Race Points, the Power Pole is not considered a race. Race Points will be awarded to Boats that are eligible (see S.2) and take the checkered flag within the time limit identified at the pilot's briefing. The APBA points scheduled shall apply representing the overall Grand Prix points finish position. The individual race points within each Grand Prix shall be awarded based upon two races within each Grand Prix as with each race receiving one half of the allotted APBA event points to determine the individual event winner. Overall event finish positions will receive points in accordance with the APBA point structure.

S5 Boat Names - It is advised that each boat name be that of the primary sponsor or Team owner. Names or graphics which are deemed to be offensive, in poor taste, or which may in the sole discretion of the Promoter affect the credibility or reputation of the sport may be refused by the Promoter.

TECHNICAL REGULATIONS

GENERAL RULES APPLICABLE TO ALL POWERBOAT P1 CLASSES

T.1 HULL All Boats shall be Monohull (see definition of Hull).

T.1a Fluorescent Bow - All Boats must have their bows painted fluorescent orange for at least 20 inches. If the Hull is of a similar orange color, then there must be a white separating band of at least 6 inches wide to ensure that the fluorescent orange band is obvious. The number of riding Crew members must be written in black in at least 10 inches high numbering, on the orange area of the nose and it must be on at least the deck and on both sides of the topsides of the Hull.

Any Boat wishing to test or practice with a different number of Crew to that stated on the bow must inform race control prior to leaving the harbor. Failure to inform race control may result in disqualification from the next race. Should any Boat be found to have raced with a different number of Crew to that stated on the bow, the penalty shall be disqualification from that race.

T.1b Strobe light - A high intensity white strobe light shall be fitted to the tallest point of each Boat for the purpose of signaling race officials and other boats that it is off plane and not racing. For an Evolution and SVS category boats the strobe light shall be mounted on the top rear of the canopy. When dual canopies are used, the light may be on or behind either canopy. This provision is recommended on P1 SuperStock category boats but is not mandatory.

This strobe light may also be used as a substitute for the orange retirement flag when returning to port under reduced power.

T.1c Mandatory Weighing - All Boat weights shall be verified by mandatory weighing after each race and after the Power Pole. No boat is permitted to refuel after racing or after the Power Pole until after they have been weighed. Failure to comply may result in disqualification from the Power Pole, the race or from the Grand Prix. The P1 TCC reserves the right to weigh Boats at any time during the event when they are being lifted into or out of the water.

T.1d Compartment Inspection Access - All compartments or chambers within the hull shall have access panels to allow inspection of all areas of the hull, including but not limited to: fuel tank compartments, ballast tank compartment(s), below floor compartments, etc.

POWERBOAT P1 SUPERSTOCK CLASS

1300 – RULES FOR UIM STOCK CIRCULATED 4. August 2017 – VERSION 4.0

INTRODUCTION

These rules are intended to ensure safe and competitive racing in a race series at a reasonable cost to the participants. The series is based on identical boats and is designed to expand and broaden the general base of participation based on the key criteria of affordability and accessibility. The class is raced at national level in various markets with some events carrying UIM International Ordinary Event status. Annual World Championship level events are also staged. The class uses stock engines and organizers work closely with the marine industry to develop and demonstrate the performance of its products. Any development that is contrary to this policy may give rise to a rule change as provided for under these rules.

1301 CONCEPT

- a. All participating boats are strictly one design and only boats and engines complying with these rules are eligible.
- b. Permission to race in the series is at the discretion of the series organizer and the organizers reserve the right to refuse entry into the series.
- c. The boats are constructed in carbon fiber and glass reinforced plastic.
- d. The boats must carry a minimum of two crew members; a driver / pilot and a navigator / throttle person.
- e. No physical modifications may be made to the hull from the original one-design drawings or specifications however technical scrutineers may approve minor running repairs if deemed necessary.
- f. No modifications may be made to the engine or engine position as set by the scrutineers.
- g. Original hull drawings are available from the series organizer on request and templates may be used at events to ensure compliance with the original design.
Outside communication during races is not permitted (other than with the start / pace boat via the vhf radio).
- i. Safety takes priority over racing at all times.

1302 CLASSIFICATION AND APPROVAL OF RACES

The race calendar is coordinated and managed by the series organizer. National events are sanctioned by the relevant national governing body and by the UIM for International races.

1303 BOAT PROVISION, OWNERSHIP AND LEASE

The series organizer sells new and used boats, leases, hires and from time to time makes boats available for use by participating teams.

1304 ONE DESIGN MINIMUM SPECIFICATIONS (ODMS) Manual

It is a condition of entry into the series that participating teams acknowledge the boats and engines available are of a certain age and will have had previous repairs. Participating teams accept the series organizer will have done everything possible to ensure boats are as even as could reasonably be assured, but that ultimately it is each competitors' responsibility to ensure their boat and engine meet the regulations.

Once inscribed for the season or a specific event, competitors will be provided with a One Design Minimum Specifications (ODMS) Manual.

The ODMS Manual, ratified by UIM, will provide competitors with a copy of the original boat design drawings and specific technical requirements for the following:

- a. Engine
- b. Propeller
- c. Fuel tank
- d. Wiring loom
- e. Minimum weight

- f. Engine lifter / jack plate
- g. Transom
- h. Controls
- i. Battery position
- j. Seats
- k. Bilge pump

1305.1 LICENCE TO RACE

To enter the series or event, all pilots must be in possession of a valid License issued by their National Authority and when racing in UIM sanctioned International Events an International License.

1305.2 AGE REGULATIONS

- (a) The minimum age for the driver is 18 years old **the navigator is 18 years old; Throttle Person is 18 years old.**
- (b) All age regulations apply at the date of the race.
- (c) All persons under 18 years of age must be accompanied at the event by a Parent/Guardian. All competitors who are under 18 on the date of the race will be required to submit written consent of their parent or guardian to their participation in the race and confirmation of their acceptance of the rules governing the race.

1305.3 PARTICIPATION CRITERIA

- (a) Only valid license holders are permitted to control the boat whilst racing.
- (b) Boats are allowed out on the water at the times designated in race instructions only or with prior agreement from the OOD. Failure to adhere to this may result in disqualification from the event and/or a fine of **\$350.00.**

Any team with a pilot competing in his or her first **3 events** must display a fluorescent orange **band around their engine cowling which MUST NOT be obscured in any way.**

- (d) These teams will be positioned furthest from the start boat during their first three events.

1305.4 ENTRIES

- (a) All entries must be made via the Official **P1** Entry Form and all accompanying terms and conditions complied with.
- (b) Entry by a team into any race event or championship is at the sole discretion of the series organizer who reserves the right to refuse entry.
- (c) Teams are responsible for the behavior of all members and crew.
- (d) The series organizer has the right to refuse any boat considered unsuitable and /or which does not conform to the requirements of the rules. The reasons for refusal shall be submitted to the team in writing.
- (e) No individual or team which has been expelled from UIM events, or who are currently under suspension by the series organizer or their own National Authority shall be permitted to officiate, serve as a race committee member, act in any capacity of assistance or participate as a boat owner or crew member in any racing event run by the series organizer. No boat belonging to that individual or team shall be allowed to compete, nor shall it be chartered or otherwise transferred except by final sale to render it eligible for a Stock series sanctioned race. The series organizer reserves the right to deny future membership and entry to anyone who has previously been expelled or suspended.
- (f) Race entries are only accepted for the full series or designated World Championship event unless otherwise agreed with the series organizer.

1306 RACE NUMBERS AND NUMBER DECALS

Race numbers are allocated by the series organizer **Noting numbers 21 & 40 have been retired and 24 has been retired by the APBA.** Teams may express a preferred number; however, these cannot be guaranteed. Number decals should conform to the following requirements:

- (a) Numbers should be black on a white background.
- (b) The font to be used is Impact Italic.

- (c) Numbers shall be a minimum of 300mm tall, on both sides of the hull, and on the deck (read correctly from the driver's position).
- (d) The minimum stroke shall be 50mm. The two digits shall be separated by no less than 50mm and the white border shall be at least 50mm from the digits.
- (e) Location - the deck number panel shall be placed immediately behind the series organizer reserved area on the deck.

1307 VALID STARTERS

On arrival in race pits/venue/event area, all teams are deemed to be under race rules and regulations. All rules will apply, as will penalties.

1308 CRANING REGULATIONS

- (a) All boats must be fitted with four lifting eyes suitably engineered to withstand lifting the boat fully equipped and fueled with an adequate safety margin. Lifting eyes fitted to the boat during construction must not be altered. The positions of the lifting eyes must be identified using standard stickers as supplied by the series organizer.
- (b) Race boat numbers must be clearly indicated on the boat's trailer on the starboard side at the hitch.
- (c) A minimum of one team member must be present at launch or recovery. All boats must be 'launch-ready on arrival at the crane (ropes, fenders on, covers off, etc.) otherwise the boat may be refused launch or recovery.
- (d) All standard health and safety procedures apply throughout any craning activity.

1309.1 SEATS

Race boats will be provided with bespoke WCC seats, frames & rails. In the interests of enhanced ergonomics, crew comfort and safety, teams are permitted to purchase from WCC through the series organizer only, tailor fitted inserts to the WCC seats at their own expense.

- (a) No other seating system is to be used and only WCC seating systems supplies through the series organizer are permitted

1309.2 FUEL

- (a) All fuel must be carried in the permanently installed fuel tank.
- (b) No secondary tanks are permitted, and fuel may not be transferred between tanks during a race.
- (c) Except where a fuel sponsor has provided fuel, fuel must be standard road-side or marina available fuel. The fuel must be available to the public and dispensed by standard road-side or marina methods only.
- (d) Boats are required to be fueled for the day unless otherwise specified and no refueling is permitted between races on the same day unless specifically mentioned in the race instructions.

1309.3 ENGINES

- (a) The specified engine used in the series is the V8 four stroke Mercury Racing 300R.
 No modifications whatsoever are allowed to the engine.
 No engine cowling modifications are permitted other than those approved by technical scrutineer. Cowlings must be in place throughout the entire period of a race.
 Engines May be sealed by the series organizer before the start of the season or specific event.
 If any work that requires an engine seal(s) to be broken is carried out, it must either be done by the series organizer's appointed agent or done in the presence of the series organizer's appointed scrutineer
 It will be the competitors' responsibility to produce their log book and/or measurement certificate at each event during scrutineering. Failure to do so will result in disqualification.
 Teams are expressly prohibited from carrying a spare engine and replacement units can only be obtained through the series organizer. Engines for the series can only be purchased through the series organizer. Privately sourced engines will not qualify for the series.

The series organizer may remove all EMMs / ECUs from the engines at the start of each event. These would then be chosen randomly by competitors and fitted by the chief technician on site.

Engine mountings shall be attached to the jack plate (lifter) with at least six bolts.

Spark plugs, engine oil and lower unit oil must be as per the specification in One Design Minimum Standards (ODMS Manual), or as supplied/provided by the organizers sponsor.

Powerboat P1 will notify all teams of any parts permitted to be changed from those originally supplied by the engine manufacturer.

1309.4 BATTERIES

- (a) Batteries shall be of the type specified in the ODMS Manual.
- (b) The ODMS Manual will specify the location of the battery and any deviation from this location will require prior approval from the scrutineer.
- (c) In the event of a battery sponsor agreement, all boats must use the battery specified.

1309.5 PROPELLERS

- (a) Participating teams are only permitted to use the designated propellers for competition purposes. Such propellers are provided exclusively by the series organizer.
- (b) All propellers available for use shall be identified by a unique serial number which will be stamped (impressed) onto the propeller.
- (c) Race propellers are randomly allocated at the start of each event by the championship organizer. Between events, the propellers are retained by the championship organizer and are only made available for racing.
- (d) Propellers may be reallocated by the series organizer during any race event.
- (e) A race propeller will be issued immediately prior to the race and checked by the scrutineer when the boat is launched and recovered. Any competitor found using an unauthorized propeller will be disqualified from that race. On completion of the race / Event. The propeller must be checked by the scrutineer or his appointed representative for inspection prior to removal and have its unique number checked. The competitor may then remove their propeller and hand it back to the technical scrutineer at the stated time and in the stated location.
- (f) The complete propeller fitting kit from thrust washer to fixing nut will be deemed part of the prop and will be handed out at the beginning of the season or specific event to each team. It should be returned immediately following the end of the season or event. Any missing items will incur replacement costs by the competitor.
- (g) Racers may own and keep a testing/training propeller which will should be used and repaired at their own expense.
- (h) During a race event if a team damages its race allocated race propeller, a replacement propeller will be provided by the series organizer. The repair of any damaged propellers is to be borne by the team.
- (i) If a competitor damages a propeller during a race it must be returned to the technical scrutineer. No repairs to the propeller may be made by the competitors or any unauthorized persons.
- (j) Failure to comply with conformity will result in a fine and/or disqualification. Propellers will be checked at random.
- (k) The series organizer may appoint a suitably qualified propeller scrutineer and his or her decision on propeller class measurement and compliance will be final and is not open to appeal. It shall be the responsibility of the competitor to ensure that the propeller is sound, particularly at the blade roots and that it is securely locked by the propeller nut.
- (l) Each race team will be required to purchase a testing propeller available from the series organizers at a preferential rate.

1309.6 MINIMUM WEIGHT

- (a) Stock boats shall have a minimum post-race weight (as raced) of TBA kilograms excluding crew and personal safety equipment.
- (b) The minimum weight is the sole responsibility of the team.
- (c) The minimum weight shall be calculated post-race using a calibrated load cell or equivalent weighing device.

- (d) All boats may be subject to post race weighing and must be made available at the request of the scrutineer and directly after racing finishes.
- (e) Non-conforming boats will be disqualified.

1309.7 STRUCTURAL STATE

Boats must finish with the forward deck hatch, rear hatch and crew escape hatches in place with original hatch fixings to be classified as a finisher. The front deck hatch fixings may be complemented with suitable marine grade adhesive tape for added security. No Modifications are permitted to the crew escape hatch.

1310 VHF RADIO

- (a) Each race boat must have on board an operational, multi-channel 25-Watt PEP VHF radio.
- (b) This VHF radio shall be capable of transmitting on the international distress frequency.
- (c) It is mandatory for at least one crew member to hold a VHF operator's license.

1311 MANDATORY MARKINGS AND DECALS

- (a) All boats must display mandatory series and event logos, as set out in the Team Agreement or as otherwise required by the series organizers.
- (b) Failure to do so will result in a fine of \$100.00 per sticker, per race.
- (c) All decals must be intact and in good order at the start of each race.

1313 SCRUTINEERS INSPECTIONS

- (a) Scrutineers shall use the current scrutineering list as a guide and equipment listing (Appendix 2).
- (b) Competitors are advised that scrutineering does not constitute a condition survey of the boat.
- (c) The scrutineering sheet may not necessarily cover every item that a scrutineer may wish to check on a particular boat.
- (d) A scrutineer shall reject a boat if it does not comply with all of the requirements of the series organizer or the UIM.

1314 TEAM MANAGER / POINT OF CONTACT

Each boat must designate a representative that is present at the event, who is responsible for team equipment, trailers, and vehicles and is the designated point of contact for the team at that event.

1315 DRIVERS' BRIEFING AND SIGNING IN

- (a) Drivers / Pilots shall 'sign in' to signify their attendance prior to the start of the briefing. Only crew members and race officials will be allowed to attend this briefing.
- (b) Roll call will be taken.
- (c) Failure to sign in by the time stated will result in a \$55.00 fine per person.
- (d) Non-attendance at this briefing may result in a \$550.00 fine per person, with a re-scheduled briefing being held at the OOD's convenience.

1316 PRACTICE

- (a) 30 Minutes of practice is highly recommended. A minimum of 3 laps must be completed by every boat, before racing can commence.
- (b) Should any Practice Session be cancelled or curtailed, the OOD shall not be obliged to resume the session or re-run sessions and the decision of the OOD shall be final.

1317.1 STARTING PROCEDURE

There must be a minimum of one-mile visibility over the whole race course and there must be no forecast or other reason to believe that there will be any less visibility on any part of the course or its vicinity throughout the expected duration of the race.

From the wet pits:

- (a) The Start Boat will communicate via radio to confirm departure from the Wet Pits. Where available, flashing amber lights will be used to also signal the departure. Full details will be provided at Drivers' Briefing.

- (b) All race boats are to follow the Start Boat to the muster area in the agreed position order. No race boat may proceed ahead of the start boat, any race boat running ahead of the start boat will be deemed as bringing the sport into disrepute and will be sanctioned accordingly.
- (c) Raising of the red flag signals the wet pits are closed and race boats may not leave the wet pits at this time. A late start procedure may be given at Drivers' Briefing.
- (d) Where possible, a parade lap around the course to the muster area will be included.

From the muster area:

- (a) The location of the muster area will be described in the Race Instructions.
- (b) Once boats are in the muster area, the yellow flag will be raised, meaning that the boats must follow the alignment procedure.
- (c) When the start boat leaves the muster area, towards the start line, the boats will line up in the pole position order and 30m astern, of the start boat. Race boats must observe a safe spreading distance (minimum 3 meters) between boats with no contact permitted. Failure to remain 30m behind the start boat will be considered a jump start and offending boats will be subject to a one-minute penalty.
- (d) A race official on the start boat will use a radio channel to control the fleet prior to the start. They will have the authority to impose penalties, as detailed below. The radio channel will be announced at Drivers Briefing.
- (e) When the starter is satisfied that all boats are in a satisfactory line and moving at a satisfactory speed, the green flag will be raised and the yellow flag will be dropped simultaneously. The raising of the green flag indicates the start of the race.
- (f) Depending on conditions, the start boat speed will be approximately 30 knots when the green flag is raised.
- (g) The official timing starts when the leading boat crosses the start-finish line, unless otherwise designated in Race Instructions. Crossing the line constitutes the start of Lap 1 of the race.
- (h) If at any time during the start procedure after the yellow flag has been raised, a red flag is raised, the start has been aborted and all boats must return, at a safe speed, to the muster area for restart, or follow specific instructions from the start boat.
- (i) Any boat that fails to line up in the muster area will not be allowed to start.
- (j) Should a boat fail to start, having lined up in the muster area, it may start within ten minutes of the time of the start provided the boat:
 - Gets permission from the safety officer / OOD to start;
 - Starts from the start position; and
 - Follows the start run going to the start/finish line when it is safe to do so.
- (k) A description of the start will be published in Race Instructions.
- (l) During the start run, if a boat passes the start boat before the green flag, it will be disqualified.
- (m) Safety takes precedence over racing at all times. Competitors should do nothing to endanger crew, spectators or other participants.
- (n) Video camera evidence may be used by Race Committee for any reason.
- (o) Standing starts: Standing or jetty starts may be used, full details will be provided in Race Instructions and confirmed at Drivers' Briefing.

Diagram 1 - Start procedure under yellow flag

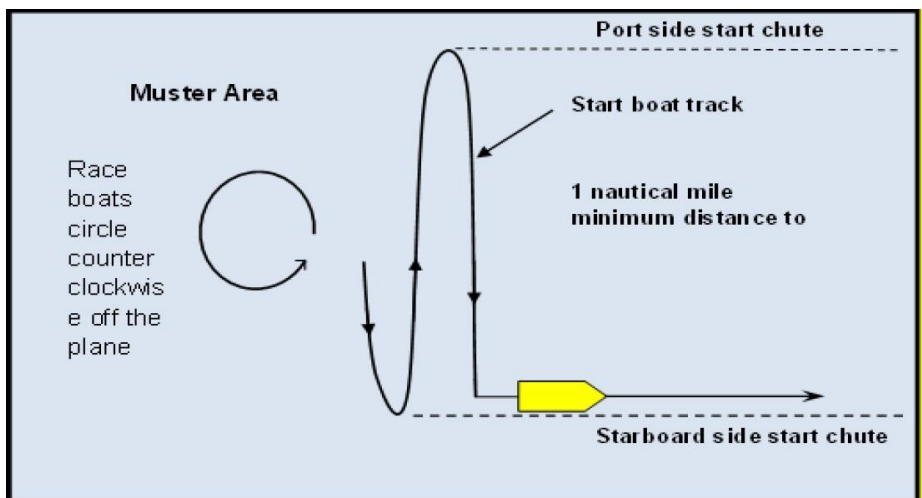
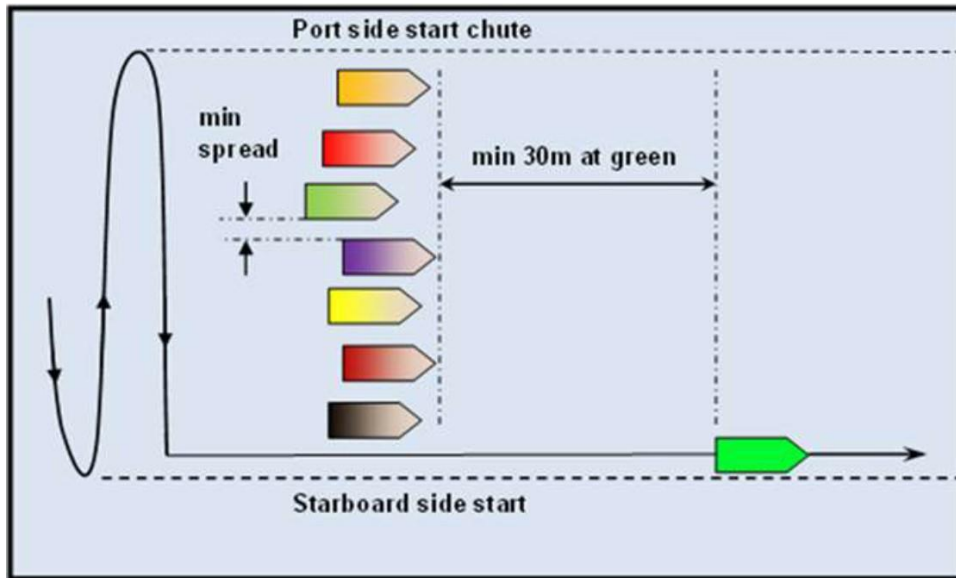

Diagram 2 - Start procedure, green flag



1317.2 POLE POSITION

- (a) The series organizer may run one or a series of timed laps to determine a set of qualifying times to determine pole position. Details will be provided at Drivers' Briefing and/or in the Race Instructions.
- (b) Alternatively, the pole position order will be defined by means of a lottery for the first race of the event.
- (c) Grid positions (if done by lottery) or the order for qualifying (for timed laps) will be advised at, or immediately following, Drivers' Briefing.
- (d) The grid for subsequent races will be based on a reverse of the current standings for the event, with the leading boat positioned on the outside of the course, furthest from pole position.
- (e) The team with the highest number of points will benefit from pole position for the final race of the event.
- (f) Pole position will be nearest to the start boat.
- (g) Teams where either one or both of the pilots has not competed and finished in a minimum of three races and achieved 'competent' sign off by the OOD will be required to start from the outside of the grid irrespective of their qualifying time.

1318 OVERTAKING

- (a) Overtaking is a competitor's responsibility on the water. It is the duty of each crew member to ensure that their boat is driven in a manner that does not compromise the safety of themselves, any other competitor or any spectator. Failure to observe this fundamental rule will result in severe penalties being applied.
- (b) Powerboat racing is a non-contact sport and crew members will be penalized if contact occurs. A constant look-out must be maintained and crews are reminded of the importance of good and efficient communication at all times.
- (c) It is the responsibility of each crew member to ensure they are fully aware of the consequences of their actions and to anticipate the actions of other boats in their immediate vicinity. All crew members must take any action necessary to avoid a collision at all times, a constant look out must be maintained and crews are reminded of the importance of good and efficient communication at all times.
- (d) The International Regulations for the Prevention of Collisions at Sea apply at all times between race boats and non-race boats.
- (e) Overtaking – any overtaking boat must give way to the overtaken boat.
- (f) A boat being overtaken must not deliberately alter its course in any way that would hinder the overtaking boat.
- (g) If a boat in consequence of its neglect of any of these rules compels another to foul, it will be penalized.
- (h) All colliding boats will be disqualified. At the discretion of the OOD this may be carried out post-race., with possible reinstatement after evidence has been reviewed.

- (i) Fouling – if any boat by its action collides with another boat, causes another boat to have a collision, or causes another boat to take avoiding or evasive action to avoid a collision – which may or may not result in that boat infringing another rule (e.g. missing or hitting a mark of the course) – they will be penalized.

1319 TURN MARKS AND MISSED MARKS

- (a) If a boat hits a turn mark, a Yellow Card penalty and/or a 30 second penalty may be applied. If a boat destroys a buoy or cuts the securing line the team will be penalized with a fine that will be commensurate with the replacement cost of the damaged mark. Replacement costs range from **\$550.00 –\$2000.00. Damage to buoy advertising banners will be charged at cost to the teams.**
- (c) A competitor may not return to a missed mark. The competitor must continue to follow the designated course passing all remaining marks correctly. Dangerous driving resulting from missing marks will result in further penalties.
- (d) The missed mark penalty is 1 minute per missed mark.

1320 COMPLETING A RACE

Upon completion of a race, a boat shall:

- (a) Turn in to the center of the course as described in drivers briefing.
- (b) Conform with the International Regulations for Preventing Collisions at Sea.
- (c) Not hinder other boats that are still racing; and
- (d) Await escort back to the Wet Pits.
- (e) All boats have a maximum of 15 minutes from the time the winning boat crosses the finish line to complete their final lap.

1321 CHAMPIONSHIP POINTS SCORING SYSTEM

Points will be awarded to race boats for each race contested. No points will be awarded if a boat is disqualified for an infringement of the technical rules. Points will be awarded as follows:

First place	20 points
Second place	17 points
Third place	15 points
Fourth place	14 points
Fifth place	13 points
Sixth place	12 points reducing by one point for each subsequent position.
DNS – Did Not Start	= 0 points
DNF – Did Not Finish	= 0 points
DQ – Disqualified	= 0 points

1322 FLAG SIGNALS

Flag Flown	From	Meaning
Yellow Flag	Start Boat	Start procedure underway
Yellow Flag	Safety/Patrol Boat	Incident in vicinity, proceed with care, no overtaking
Green Flag	Start Boat	Race Start
Red Flag	Start Boat (during start)	Start aborted
Red Flag	Official Boats	Race stopped
Checkered Flag	Finish Line	Race finished
Checkered Flag & Red Flag	Finish Line	Race curtailed
Black Flag & Race Boat No.	Start Boat	Disqualified from race; stop racing
White Flag	Finish Line	Last lap indicator
Orange Flag – static	Competing Boat	Retirement
Orange Flag – waving	Competing Boat	Retirement and in distress
Black flag with Yellow X	Official Boat	Identification as official boat

- Yellow Flag – on seeing the yellow flag signal from an official boat, Driver and Co-Drivers must acknowledge the signal, proceed with caution, not overtake other race boats whilst in the area of the incident and keep clear of any danger areas. Any competitor who ignores or abuses the yellow flag signal will be penalized. **The Start or a Rescue boat** yellow lights may be used in conjunction with yellow flags. These lights shall have the same meaning as a yellow flag.
- Red Flag – on seeing the red flag signal, all boats shall come off the plane stop racing immediately, turn in to the center of the course and await further instructions, **The Start or a Rescue boat red lights may be used in conjunction with red flags. These lights shall have the same meaning as a red flag. Infringement of any of the above may result** in disqualification and/or yellow card and/or a time penalty or any combination.
- Black Flag - any race boat deviating from the course into restricted areas, displaying conduct deemed to be unsporting or dangerous or having damage to the boat considered to be dangerous, will be shown the black flag the next time it passes the start boat and will be disqualified from the race and is not eligible for appeal. Disqualified boats must return to wet pits area, safely moving off the course and avoiding any interference with the race or other race boats.
- Disqualified boats will not be awarded points for that race and may be fined.

1323.1 Additional Penalties

In addition to the penalties outlined in the General Rules of the UIM Rulebook, the following additional penalties will apply:

If the resulting associated additional penalty includes a time penalty, then the appropriate time will be added to overall elapsed race time if the card is given for an on-water offence.

Penalty Card	Number of Offence	Associated Additional Penalty
Yellow Card	First yellow card	\$115
	Second yellow card	\$230 + 1 min penalty
	Third yellow card	\$350 + 2 min penalty
Double Yellow Card	First double yellow card	\$280 + 2 min penalty
	Second double yellow card	\$450 + 3 min penalty
Three Yellow Cards will result in a Red Card and suspension for the following race.		
Red Card	First offence in calendar year	\$500 + disqualification

	Second offence in calendar year	\$1000 + disqualification from the remainder of the series for the crew and team
--	---------------------------------	--

1323.2 CHAMPIONSHIP SPECIFIC PENALTIES

At the discretion of the OOD, a yellow card penalty may also be applied in conjunction with the penalties listed below. A written penalty notice will be given and the time of the penalty written on the notice.

- (a) Smoking in the defined wet or dry pits: \$230.
- (b) Fuel transfer outside the designated fueling area: \$350.
- (c) Persons on boats during lifting or craning: \$350 to the driver of the boat.
- (d) Failure in launch/ramp discipline: first offence – warning and/or \$120; second offence – \$230.
- (e) Late or non-attendance at prize giving ceremony: \$350.
- (f) Failure to present engine or race boat for technical examination: disqualification.
- (g) Failure to raise and fly retirement flag when able: \$120.
- (h) Failure to report Retirement to Race / Safety Control: \$120.
- (i) These penalties are not exclusive and do not protect the offender from further action by the series organizer / National Authority / UIM. Penalties listed above will be applied by the OOD and may be protested. Protests must be lodged within one hour of the penalty being issued.

1324 IDENTITY TAGS

All pilots will be issued with waterproof temporary identification which must be worn on the right wrist at all times during racing, practice and testing.

1325 PODIUM PRESENTATION

All podium finishers must wear their race overalls at the podium ceremony. Winners caps may be provided by the Organizer which should also be worn. Failure to do so will result in a \$120 fine per pilot.

Appendix 1 – One Design Minimum Standards Manual

- Engine
- Propeller
- Fuel tank
- Wiring loom
- Minimum weight Engine lifter / jack plate
- Transom
- Controls
- Battery position
- Seats
- Bilge pump

Appendix 2 – Scrutineering Sheet



Race Number #:

P1 SSTK - Scrutineers Check List

Item	Yes	No	Notes
All teams have read the Advanced Race Instructions for the event they are attending and can produce a			
Lifting Strops and lifting eyes Inc Certification			
Battery installation and isolator switch			
All cables and controls			
Foot Throttle or hand throttle			
Steering system			
Seats, Mouldings, Rails			
Engine Kill Switch Operational			
Engine Mounting and Bolts Secure			
Engine Sealed seal No` s			
Skeq Standard			
Reverse Gear operational			
5kg Anchor and 50 m line			
Towing Eye, Painter /Towing Line / dock line x 2			
MIN 1 x 1.5 kg power Fire Extinguisher			
Propeller Serial Number and secured by locking nut			
Working VHF and crew Intercom Operational			
Bilge Pump and Hand Bailer			
Fuel tanks, lines, earth wire, shut off valve			
Helmets x 2			
Life Jackets x 2 with minimum buoyancy			
Canopy hatch latch fully operational			
Whistle, Compress, sheaved Knife (both crew)			
Race Suits x 2, suitable footwear			
Race Numbers & Branding ROOKIES ORANGE IDENTIFICATION			
Boat Number on trailer?			
Flares mini carried by both crew (UK only)			
Retirement flag or Strobe light			
Buoyancy bags			
Weight Check (min 1450kg as raced inc crew kit)			
Engine HEIGHT check			
Fuel Tested ,Oil type			
Mandatory Branding			
Hull for Modifications ,sharp edges, protrusions			

Scrutineer's Signature _____

Drivers Signature _____

Date _____

SS 2 POWERBOAT P-1 (OPEN CANOPY ONLY) USA SHORT COURSE

SAFETY RULES

Note: These safety rules are for Powerboat P-1 Superstock 28SS (250 & 300) Class's and any other non-canopied (unrestrained) race boats with top speeds less than 85 MPH competing on race courses less than or equal to 3.0 Statute Miles. For classes or racecourses not meeting the above criteria **(which includes the Powerboat P-1 28R canopy)**, the standard offshore safety rules shall apply,

Due to the many different characteristics of APBA events, the APBA General Safety Rules do not apply to the Unlimited Category, Offshore Category, and Special Events.

A. Racing is an inherently dangerous sport and each competitor assumes the risk when he/she participates in an event. While everyone involved — owners, drivers, crewmembers, officials, promoters, and the sanctioning body — can take, and have taken, measures to reduce the risk of serious injury, the risk cannot be eliminated and, in fact, will always be present. It is the participant's responsibility to advise their spouses and next of kin APBA cannot be, and is not, responsible for all or even most aspects of the safety effort. That responsibility instead rests with the various participants in the events as follows:

1. APBA: APBA officers, officials, agents, and representatives are not present at APBA events with sufficient frequency to make any representations or warranties of safety to any competitor or other person. As a result, APBA cannot and does not take responsibility to ensure the adequacy - for purposes of safety - of the racing facility, safety personnel or equipment, or conditions of the premises including the waterway. The participants are solely and ultimately responsible for satisfying themselves as to the safety of the premises, pit areas and race course.
2. Participants: All participants are obligated to inspect the racing facilities, including the pit area and race course, including all of the conditions that would affect their participation in, before and after the event. Participants are solely and directly responsible for the safety of their race craft and racing equipment, are obligated to perform their duties whether as an owner, driver, or crew member in a manner designated to minimize, to the degree possible, the risk of injury to themselves and others. **NEITHER APBA NOR THE PROMOTER/ CONDUCTING CLUB CAN OR WILL BE RESPONSIBLE FOR THE ADEQUACY OF A PARTICIPANT'S RACE CRAFT, RACING EQUIPMENT, OR RACING ACTIVITY TO ACCOMPLISH THIS PURPOSE.**

B. The Referee of a sanctioned regatta must require that:

1. All proper officials are present and functioning during the conduct of the regatta.
2. Adequate facilities are available for the efficient conduct of the race before the sanctioned testing or racing begins.
3. A properly equipped ambulance will be used and either a doctor, registered nurse, paramedic, or an EMT will be in attendance.
 - 1) If for any reason the ambulance leaves the race site, all testing or racing activities must be stopped immediately until another ambulance is on-site.
4. Three (3) safety and patrol boats as an absolute minimum, and more if conditions warrant, are available for duty on the course at all times. Only authorized personnel shall man safety and/or patrol boats. Personal Water Craft (PWC) may be used in addition or in lieu of safety and patrol boats. All safety and patrol personnel must be a minimum of 18 years of age and must sign the APBA insurance waiver.
5. There must be at every race a turn judge located in certain turns specified by the Referee whose duty it shall be to watch for and report violations of safety and racing rules. Said judges shall be in boats or on land or docks with an unrestricted view of the turn. If the judge is located on a boat, the boat must be anchored a minimum of 150 feet inside the race course. Final placement is at the discretion of the Referee or Chief Medical and Safety Director.
6. A minimum of three (3) medical rescue boats properly staffed and equipped. One (1) of which must be ALS equipped. (Note: ALS requirements vary from state to state and shall be defined by the local hospital district, medical examiner, ambulance service or medical person in charge at each race site.

Exact reasonable and required ALS equipment shall be agreed upon by the local governing authority and the Chief Medical and Safety Director at each event)

a) The exact number of safety and patrol boats and medical rescue boats required for each race course shall be determined by the Referee and/or the Chief Medical and Safety Director at each event.

C. Helmets and Life Jackets: A driver (and passenger, if any) when operating registered equipment at any time while at a sanctioned regatta, must wear complete safety equipment, including helmet and life jacket, except where exempt, with the following exception: Helmets may be removed only (1) when the boat is stopped or operated off-plane at idle speed, and (2) when there are no other race boats operating on plane on the race course or in the vicinity so as to create a danger, or (3) when the driver's boat is tethered to a tow boat. The helmet only may be removed by drivers of stalled boats while in the center of the course. Considering the fact that there is no safest life jacket and helmet that will eliminate all risks, the participants are solely and ultimately responsible for selecting a suitable helmet and life jacket. Only those considered in good condition may be used.

1. Helmets must meet the specifications set forth by any of the following: American National Standards Institute, Inc., Snell, or military specification helmet designed for military aircraft — Mil-Spec helmets (CGF LA100, LH050, LH150, LH250; Gentex HGU-84/P) and Peltor helmets (Rally Pro Helmet EN ECU 04 or 05) are acceptable.
 - a) The upper fifty percent (50%) of the helmet must be a single color of the following: yellow or fluorescent (high visibility) yellow or lime green or orange or international orange or fluorescent red.
 - b) Half-shell and 3/4 type helmets are not allowed.
2. Life jackets: All racing life jackets must be constructed in compliance with the “APBA Life Jacket Basic Manufacturing Specifications” dated April 8, 1991. Copies are available from APBA National Headquarters.
 - a) All racing life jackets must have a permanent affixed (sewn in) manufacturer's label indicating:
 - i. The date of manufacture or the date of recertification.
 - ii. The manufacturer's or re-certifier's company name.
 - iii. The type category (A or A-100 only)

“A” For use in an open cockpit and by an unrestrained occupant. Maximum boat speed is less than 100 mph.

“A-100” For use in an open cockpit and by an unrestrained occupant. Maximum boat speed is 100 mph or greater. A-100 may also be used where A is required.

- iv. Color Requirements: All life jackets shall have at least 70% of the upper surfaces above the waist, both front and back, international orange or yellow in color.
- v. Every driver shall demonstrate that his life jacket will function properly when requested by the referee.

D. Safety Stop Switches: All non-driver restrained boats must be equipped with an electrical engine stop switch capable of stopping the engine, and electric fuel pump, if so equipped, if the driver is separated from the boat. A stop switch must consist of a line which must attach to the boat manufacturer's supplied kill switch inside the hull to facilitate continuous operation of the engine and a tether less than four feet in length, with a switch activating force less than 30 pounds. All safety switch tethers must be permanently attached to life jackets by a breakaway device with a pull force greater than the switch operating force.

E. Race Course:

1. Race courses for Powerboat P-1 USA shall be equal to or greater than 0.75 statute miles but not greater than 3.0 statute miles in length.
2. All turns, chutes or slots shall be marked by a turn buoy. Turn buoys shall be orange in color and a minimum of three (3) feet in diameter. When possible, it is preferred that all turn buoys be a minimum of five (5) feet tall and tetrahedron in shape. Turn buoys should be constructed of vinyl or plastic material capable of withstanding the conditions encountered in offshore racing. Buoys shall be constructed so that they do not inflict major damage to any race craft striking said buoys.
3. Chutes and Slots may be established on the race course to aid in scoring or enhance the safety of the

racers or spectators.

4. The minimum width of the race course shall be 100 yards
 5. The starting line shall be of sufficient length to permit all starters to start abreast without interference. Both ends of the starting line shall be plainly marked, and the flagman, if any, shall be on the line, clearly visible to all contestants. All competing boats must cross the starting line between the markers indicating the official starting line and the start finish boat or officials' stand.
 6. The minimum distance from the outside of any race course to the shoreline or navigable channel, must be at least 250 feet unless said navigable channel is closed by the Coast Guard or local authority permit.
 7. The minimum distance from the outside of any race course to a vertical barrier where spectators may or may not be located on top of (sea wall, etc.) must be 50 feet. Said barrier or sea wall must be a minimum of 48 inches in height.
 8. Spectator boats are not allowed inside the course and may not be closer than 500 feet to the outside race lane.
 9. Boats may not race closer than 50 feet to any fixed object. Said object shall be marked by a buoy at least 50 feet from the object. All race boats must negotiate the buoy as a mark of the course.
 10. Turns greater than 90 degrees must be marked with 2 buoys and a minimum of 250 feet apart.
- F. All marks of the course must be negotiated as designated by these rules, pre-published race instructions or as directed by the referee or his designee at the Final Drivers' Meeting.
- G. All participants must wear closed footwear when driving boats or working as pit crew (working on boats, launching boats, or retrieving boats) in the restricted area.
- H. The Referee shall prohibit use of any equipment he deems unfit for service.
- I. When driving or riding in any racing craft, eye protection in the form of a helmet face shield, goggles or ANSI/OSHA approved safety glasses with restraint straps shall be mandatory.
- J. Flipped drivers, if uninjured, should clasp hands above head as an "okay" signal.
- K. After crossing the finish line, a boat shall not interfere with any boat still in the race so as to affect the time of such boat at the finish.
- L. Contact between boats is expressly forbidden and will not be tolerated. The Referee shall determine which driver is "at fault" in each incidence of contact and that driver shall be subject to penalties including but not limited to, fines, yellow cards, red cards, disqualification from the event or suspension from the series. In addition, the driver "at fault" shall be responsible for all damages to both boats.
- M. Boats and participants shall be controlled by all rules after the warning or preparatory signal has been given, and until the particular boat has finished and is free and clear of the race course or has withdrawn from the race and left the course.
- N. If requested, it is the responsibility of the driver or owner to submit his equipment for safety inspection. If, in the judgment of the Inspector or Referee, a boat is unseaworthy, unsafe, or unmanageable, he shall refuse to allow the boat to participate in the race. The Referee, at his discretion, may require any flipped boat or boat involved in any accident to be re-inspected before entering another heat of racing.
- O. No contestant shall participate in a race, nor shall any official serve in an official capacity, after having consumed alcohol or controlled substances or while intoxicated.
1. The phrase "after having consumed or while intoxicated" shall mean from midnight before the day of the race and until the driver has been cleared through inspection.
 2. Intoxicated means under the influence of
 - a) Alcohol,
 - b) A controlled substance,
 - c) Any drug, or
 - d) Any combination of the above, such that there is an impaired condition of thought and action and loss of normal control of a person's faculties to such an extent as to endanger any person.
 3. At all APBA sanctioned Regattas a Breathalyzer test may be required of any participant (anyone required to sign the insurance participant form) under the following guidelines:

- a) A Race Committee may, at the time of issuing a sanction, set in place a program to test any or all participants.
 - b) The Referee has the authority to require any or all participants (including non-member holders of hot pit passes) to submit to a Breathalyzer test.
 - c) The Risk Manager or Race Director shall have the authority to require the referee to submit to a Breathalyzer test and/or to ask the referee to test any participant.
 - d) Permissible Breathalyzer tests include:
 - 1) Breathalyzer test administered by Police, Sheriff, or another qualified agent.
 - 2) Over-the-counter Breathalyzer test administered by the Referee or his designee. Participants failing this type of test may pursue, at their own expense, a retest to verify results. The retest must be administered on site under the observation of the referee or his designee.
 - e) Tests may be administered on race day from 7:30 AM until one-half hour after the final heat has concluded.
 - f) Criteria: The maximum allowable test limit shall be no greater than .00 BAC. Refusal to take the test will be considered a failed test.
- P. The areas in which the cranes are located shall be separated from all other pit areas. Access to the crane area shall be restricted and limited to authorized personnel.
- Q. With regard to weather conditions, racing shall take place at the Referee's discretion.
- R. Local race committees shall establish no ground rule which employs a man in the water or a man in a stopped boat as a course marker.
- S. It shall be the duty and responsibility of the officials solely to provide an adequate area for the firing of the cannon.
- T. Race coverage by overhead aircraft shall be conducted in the following manner:
 - 1. All persons wishing to fly any aircraft over a race course in which power boats are competing shall obtain prior approval from the Referee and be briefed as to any rules that may be imposed.
 - 2. Flight permission shall be granted at the discretion of the Referee, giving priority to those crafts whose purpose shall be race patrol.
- U. The Referee shall immediately submit incident (accident) report forms following the event and follow all instructions contained in the current form. This does not preempt local authorities from reporting those accidents required by state and federal law. Race officials will assist local authorities in completing reports if necessary.
- V. When APBA classes compete for "World Championships," APBA safety rules shall apply.
- W. No contestant shall participate in an APBA-sponsored event with any type of splint, including, but not limited to, a cast or brace applied to his body without showing written authorization from a medical doctor and approval by the Referee at the particular event.
- X. Safety and Rescue Teams
 - 1. The Safety & Rescue Team is defined as the team designated to provide medical care and rescue services to APBA boat racers. These teams must meet the criteria set forth in the category Safety & Rescue Team section of the rule book.
 - 2. Powerboat P-1 USA shall establish minimum Safety & Rescue Team criteria, including personnel, equipment and operations.
 - 3. If, during competition or testing, a driver appears to need medical assistance or rescue services, the Turn Judge or Safety & Rescue Team must signal the Referee to stop the race.
- Y. Rescue Boats:
 - 1. All rescue craft shall have radio communications with the Referee, or his designee.
 - 2. The rescue craft crew shall lift all accident victims from the water in as nearly a horizontal position as possible on a Stokes, or backboard type litter.
 - 3. The rescue boat staff shall consist of a minimum of two persons. All personnel on the Rescue Boat must be a minimum of 18 years of age.

4. It is recommended that one person in the rescue craft shall be capable of providing basic life-support administration.
 5. Personal Water Craft (PWC) equipped with “rescue sleds” may be used in addition to, but not in lieu of the required minimum of three (3) Rescue Boats.
- Z. Rules passed by the National Safety Committee take precedence over those written by any category. Categories, when writing rules regarding a subject covered by General Safety Rules, may only add more restrictive details. These more restrictive rules will then prevail for that category.
- AA. A violation of any General Safety Rule and/or Category Safety Rule may result in a disqualification for the class in which the violation was found, effective with the first race of the day of the violation, and until the violation is corrected.
- BB. The following substances are forbidden to be present in gasoline for health and safety reasons during any APBA event: Acrylonitrile, Aminodiphenyl, Aniline, Benzene, Benzidine, Beryllium compounds, Bromine compounds, Chloromethyl ether, Chlorine compounds, Ethylene oxide, Hydrazine compounds, Manganese compounds, Nitrobenzene, Nitrochlorobenzene, Nitrogen compounds, Nitrodiphenyl, Propylene oxide and Tert Butyl Toluene. If concentrations of any of these substances greater than that allowed in commercial gasoline by the current EPA upper limits are found in a gasoline sample, the penalty will be a disqualification from the race and a two-year suspension. A second offense will result in a lifetime suspension.

APBA OFFSHORE HALL OF CHAMPIONS

In order to qualify for consideration for the APBA Hall of Champions (HOC), an offshore team (driver and throttleman) must win a national high point championship (minimum of four APBA sanctioned races) or a divisional high point championship (minimum of 3 APBA sanctioned races). Among the teams that are qualified for possible inclusion in the HOC two members (driver and throttleman) shall be selected from the National Classes; two members (driver and throttleman) shall be selected from the Bracketed Classes. Candidates must be from the same team, racing in the same boat. Substitute drivers or throttlemen are not allowed for HOC except in cases of extreme hardship. Hardship is defined as serious injury to a driver or throttleman that puts the driver or throttleman out for the rest of the season, a death of a driver or throttleman, or a death in the immediate family of a driver or throttleman. The award is bestowed on drivers and throttlemen only. A minimum of one APBA offshore team will be inducted into the APBA Hall of Champions each year. In order to be considered for the HOC, a class must have a minimum of three (3) distinct boats participate in the class during the course of the season (December 1 - November 30).

National Classes HOC:

The driver and throttleman chosen from the National Classes are based on the following criteria:

- a) National High Point Championship (minimum of four APBA sanctioned races): 50 points
- b) UIM World Championship: 45 points
- c) APBA National Championship: 30 points
- d) Kilo record: 25 points
- e) High Point Championship in National Class with highest number of participating teams within APBA: 10 points.

4. Bracketed Classes HOC:

The driver and throttleman chosen from the Bracketed Classes are based on the following criteria:

- a) National High Point Championship (minimum of four APBA sanctioned races): 50 points,
- b) UIM World Championship: 45 points
- c) APBA National Championship: 30 points
- d) High Point Championship in the Bracketed Class with highest number of participating teams within APBA: 10 points.

5. Offshore Hall of Champions Tie Breaker:

Ties in Hall of Champions points shall be resolved according to the following criteria:

- a) The team that has participated in the largest number of APBA offshore events shall be considered as having defeated those boats with equal HOC point totals that have competed in fewer events.
- b) In the event that a tie still exists after a) is applied, the team that has defeated the largest number of boats during the season shall be considered as having defeated those boats with equal HOC point totals that have defeated fewer boats.
- c) In the event that a tie still exists after a) and b) have been applied, the team that has completed the greatest number of racing miles shall be considered as having defeated those boats with equal HOC point totals that have completed fewer racing miles. The racing miles completed by a boat in a race shall be determined by the distance covered from the starting line to the last checkpoint at which the boat was officially scored.
- d) In the event a tie still exists after a), b), and c) have been applied, the team with the largest number of first place finishes shall be considered as having defeated those boats of equal HOC point totals that have fewer first place finishes.

APBA NATIONAL HIGH POINT CHAMPIONSHIPS

1. The APBA National High Point Championship shall be awarded to the team within each class that scores the highest point total in all regular season races plus the points awarded for the APBA National Championship race, plus shall be declared the National Champion in its class.
2. In order to be declared the National Champion in any class, the boat must have attended a minimum of $\frac{3}{4}$ (rounded down in the event of an odd # of races) of the regular season races and actually run or compete in the APBA National Championship race. For purposes of clarification, “attended” shall mean the boat, driver, and throttleman were present, ready to run with all entry fees paid. If a race was cancelled due to circumstances beyond control or the boat broke down prior to the start of the race, then the “attended” requirement shall be considered satisfied.
3. In case of a tie, see the current rule in the APBA rule book.

_____ Number on Boat
 CLASS: _____ Registered Boat #: _____
 TEAM NAME: _____
 NAME ON BOAT: _____
 REGISTERED HULL: _____ Replacement/Substitute HULL: _____

EVENT: _____



		YES	NO			YES	NO
DECALS	OPA Decals			EXTERIOR	Tow Eye/Ring		
	APBA Decals				Deck Hand Rail		
	POWERBOAT P1 Decals				External Tie Bar		
	U.S.A. Flag				Nonskid		
	OPA High Points Sticker				Cleats Recessed		
	Other Sanction Stickers Removed				Transom Grab Rail		
	Boat Number: Port & Starboard						
	Boat Number: Deck						
COCKPIT	Windshield/Screens			EXHIBITED	Anchor		
	Canopy				100' Tow line		
	Inside Canopy Hatch Covers Yellow				2 Smoke Flares		
	Kill Switch(es)				Signaling Device		
	Racing Bolsters/Seats				First Aid Kit		
	5-Point Harness type: _____				Air Horn		
	Interlocking Intercom Connections				VHF		
	Hole in Firewall				PFDs		
	VHF				Helmets		
	Extinguishers - (under 26' only 1 Extinguisher)						

		YES	NO
ENGINE COMPARTMENT	Inside Hatch Covers(s) Yellow		
	Fire Suppression System (1 in each engine compartment)		
	Drive Shaft Covers		
	2 Bilge Pumps type: _____		

	PFD Brand / TYPE	DATE	HELMET BRAND / TYPE	DATE	RATING
DRIVER					
THROTTLEMAN					
NAVIGATOR					

On Board Air System Type				
	C.I.	PSI	VIP Date	Hydro Date
TANK 1				
TANK 2				

COMMENTS: _____

Boat Representative: _____ Signature: _____ DATE: _____

Inspector: _____ Signature: _____ DATE: _____

Assistant to Inspector: _____ Signature: _____ DATE: _____

19/03-28